

## 5A 2-4 Cell Buck-Boost Switching Battery Charger

### General Description

The RT9490 is a highly-integrated 5A Buck-Boost switch mode battery charge management and system power path management device for 2-4 cell Li-Ion and Li-polymer battery. The low impedance power path optimizes switch-mode operation efficiency, reduces battery charging time and extends battery life during discharging phase. The I<sup>2</sup>C serial interface with charging and system settings makes the device a truly flexible solution.

The recommended junction temperature range is -40°C to 130°C, and the ambient temperature range is -40°C to 85°C.

### Ordering Information

RT9490 □  
 Package Type  
 WSC: WL-CSP-56B 2.93x3.46 (BSC)

Note:

Richtek products are Richtek Green Policy compliant and compatible with the current requirements of IPC/JEDEC J-STD-020.

### Applications

- Smart Phone/Tablet/Chrome Book
- Drone
- Portable Device and Accessory

### Features

- High Efficiency, 750kHz/1MHz/1.5MHz Programmable Frequencies, Synchronous Switch-Mode Buck-Boost Charger
  - ▶ 96.7% Charge Efficiency at 2A with 9V Input and 8V Battery
  - ▶ Supports 3.6V to 24V Input Voltage Range
  - ▶ Average Input Current Regulation (AICR)
  - ▶ Minimum Input Voltage Regulation (MIVR)
- Supports USB On-The-Go (OTG)
  - ▶ 93.8% OTG Efficiency at 2A with 8.4V Battery and 5V Output
  - ▶ Output Voltage with 10mV resolution to support USB-PD
  - ▶ BAT Current Limit Regulation (BCLR)
- Supports Dual Input Selection
- Supports BC1.2, Host mode and FRS/Seamless
- Supports 11-Channel, 16-bit ADC
- Low Battery Quiescent Current
- High Accuracy for Charger CV and ICHG
- Protection
  - ▶ Over-Temperature Protection (OTP)
  - ▶ Junction Thermal Regulation (JTR)
  - ▶ Input Protection (VAC OVP/VBUS OVP/OCP)
  - ▶ Battery Overvoltage Protection (VBAT OVP)
  - ▶ System Voltage Protection (VSYS OVP/UVP)
  - ▶ System Over-Load Protection (VSYS OLP)
  - ▶ Cycle-by-Cycle Overcurrent Protection (OCP)
  - ▶ OTG Low Battery Protection (OTG LBP)
  - ▶ OTG Voltage Protection (OTG OVP/UVP)

### Simplified Application Circuit

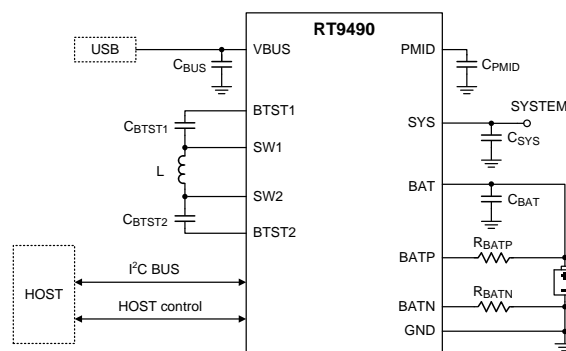

## Marking Information



2K: Product Code  
XXYY: Wafer ID with Check Sum  
CCC-RRR: IC Coordinate (X, Y)  
YMDNN: Date Code

## Pin Configuration

(TOP VIEW)

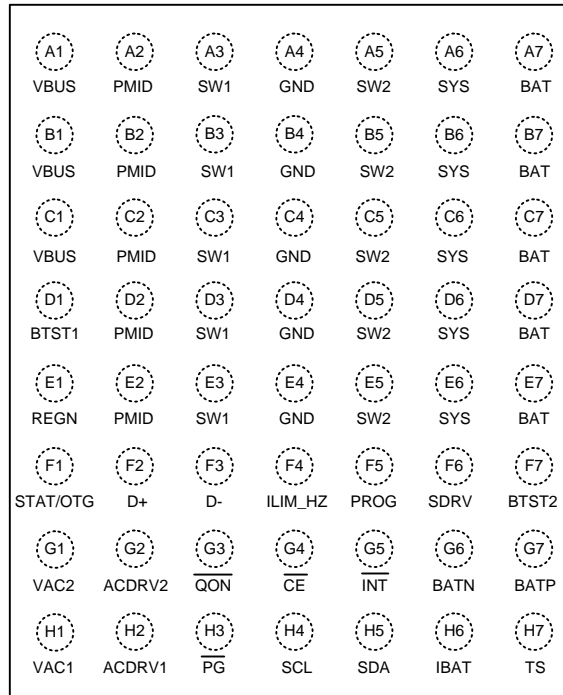

WL-CSP-56B 2.93x3.46 (BSC)

## Functional Pin Description

Pin No.	Pin Name	I/O	Pin Function
A1, B1, C1	VBUS	P	Charger input voltage. The internal current sensing circuit is connected between VBUS and PMID. Connect two 10 $\mu$ F capacitors from VBUS to GND and place as close as possible to VBUS.
A2, B2, C2, D2, E2	PMID	P	Connected to the drain of high-side switching MOSFET (Q1). Connect three 10 $\mu$ F and a 0.1 $\mu$ F capacitors from PMID to GND and place as close as possible to PMID.
A3, B3, C3, D3, E3	SW1	P	Switching node one connecting to output inductor. Internally SW1 is connected to the source of the high-side switching MOSFET (Q1) and the drain of the low-side switching MOSFET (Q2).
A4, B4, C4, D4, E4	GND	P	Power Ground.
A5, B5, C5, D5, E5	SW2	P	Switching node two connecting to output inductor. Internally SW2 is connected to the drain of the low-side switching MOSFET (Q3) and the source of the high-side switching MOSFET (Q4).

Pin No.	Pin Name	I/O	Pin Function
A6, B6, C6, D6, E6	SYS	P	Charger output connection point. Connected to the drain of high-side switching MOSFET (Q4) and the internal current sensing circuit between SYS and BAT. Connect five 10 $\mu$ F and a 0.1 $\mu$ F capacitors from SYS to GND and place as close as possible to SYS.
A7, B7, C7, D7, E7	BAT	P	Battery connection point to the positive terminal of the battery pack. The internal current sensing circuit is connected between SYS and BAT. Connect two 10 $\mu$ F capacitors from BAT to GND and place as close as possible to BAT.
D1	BTST1	P	The high-side switching MOSFET (Q1) driver positive supply. Internally, the BTST1 is connected to the cathode of the bootstrap diode. Connect the 47nF bootstrap capacitor from BTST1 to SW1.
E1	REGN	P	PWM low-side driver and internal supply output. Internally, REGN is connected to the anode of the bootstrap diode. Connect a 4.7 $\mu$ F capacitor from REGN to GND. The capacitor should be placed close to the IC.
F1	STAT/OTG	DIO	Open-drain charger status output. Connect the STAT pin to a logic rail via 2.2k $\Omega$ to 10k $\Omega$ resistor. The STAT pin indicates charger status. Open-drain OTG mode enable control input. Active high. Connect the OTG pin to a logic rail via 2.2k $\Omega$ to 10k $\Omega$ resistor.
F2	D+	AIO	Positive line of the USB data line pair. D+/D– based USB host/charging port detection. The detection includes data contact detection (DCD), primary, secondary detection in BC1.2 and manual control mode.
F3	D-	AIO	Negative line of the USB data line pair. D+/D– based USB host/charging port detection. The detection includes data contact detection (DCD), primary, secondary detection in BC1.2 and manual control mode.
F4	ILIM_HZ	AI	Input current limit setting and HZ mode control. A resistor divider is connected to ILIM_HZ pin by pull up resistors from REGN to GND. The pin voltage is calculated as $V_{ILIM\_HZ} = 1V + 800m\Omega \times ILIM$ , where ILIM is target input current limit. The input current limit for charger is the lower setting between ILIM_HZ and AICR register. When the pin voltage is below 0.75V, the buck-boost converter stops switching and REGN on. When the pin voltage is higher than 1V, the converter resume switching.
F5	PROG	AI	Charger POR default setting program. A resistor is connected from PROG to GND to set battery cells for default charging profile and switching frequency. The resistor connected to PROG is recommended to have 1% or 2% resistance tolerance.
F6	SDRV	P	External Ship N-channel FET gate driver output. The SDRV is connected to external ship FET, the SDRV is always turned off when in ship or shutdown mode. Without using ship FET, must connect a 1nF/50V capacitor from SDRV to GND.
F7	BTST2	P	The high-side switching MOSFET (Q4) driver positive supply. Internally, the BTST2 is connected to the cathode of the bootstrap diode. Connect the 47nF bootstrap capacitor from BTST2 to SW2.
G1	VAC2	P	VAC2 voltage sensing. When a voltage on VAC2 is above VAC2_UVLO, it represents input source plug in on port2. When there is no external AC-RBFET2, the VAC2 must connect to VBUS
G2	ACDRV2	P	External AC-RB N-channel FET gate driver output. The ACDRV2 is connected to external AC-RBFET2, the charger turns on AC-RBFET2 by increasing ACDRV2 voltage 5V above the AC-RBFET2 drain when the turn on condition valid. When there is no external AC-RBFET2, the ACDRV2 must connect to GND.

Pin No.	Pin Name	I/O	Pin Function
G3	$\overline{\text{QON}}$	DI	Ship FET control input. When the device is in ship mode, a logic low duration with $t_{\text{QON\_EXIT\_SHIP\_DLY}}$ turns on Ship FET to exit ship mode. A logic low duration with $t_{\text{QON\_RST}}$ turns off the ship FET and stops converter switching for $t_{\text{SYS\_RST}}$ and resumes to provide system reset. Pull-High to internal bias circuit via 200k $\Omega$ resistor.
G4	$\overline{\text{CE}}$	DI	Charge enable pin. Active low. When this pin is driven low and $\text{REG\_CHG\_EN} = 1$ , battery charging is enabled. Do NOT leave this pin floating.
G5	$\overline{\text{INT}}$	DO	Open-drain interrupt output. Active low. Connect the $\overline{\text{INT}}$ to a logic rail through 10k $\Omega$ resistor. The $\overline{\text{INT}}$ pin sends active low pulse to host to report charger device status and fault.
G6	BATN	AI	Negative battery voltage sensing. Connect to the negative terminal of battery pack. It is recommended to place 100 $\Omega$ series resistor between BATN and the negative terminal of battery pack.
G7	BATP	P	Positive battery voltage sensing. Connect to the positive terminal of battery pack. It is recommended to place 100 $\Omega$ series resistor between BATP and the positive terminal of battery pack.
H1	VAC1	P	VAC1 voltage sensing. When a voltage on VAC1 is above than $\text{VAC1\_UVLO}$ , it represents input source plug in on port1. When there is no external AC-RBFET1, the VAC1 must connects to VBUS
H2	ACDRV1	P	External AC-RB N-channel FET gate driver output. The ACDRV1 is connected to external AC-RBFET1, the charger turns on AC-RBFET1 by increasing ACDRV1 voltage 5V above the AC-RBFET1 drain when the turn on condition valid. When there is no external AC-RBFET1, the ACDRV1 must connects to GND.
H3	$\overline{\text{PG}}$	DO	Open-drain power good indicator. Active low. Connect the $\overline{\text{PG}}$ pin to a logic rail via 2.2k $\Omega$ to 10k $\Omega$ resistor.
H4	SCL	DI	I <sup>2</sup> C interface clock. Connect SCL to the logic rail through a 10k $\Omega$ resistor.
H5	SDA	DIO	I <sup>2</sup> C interface clock. Connect SDA to the logic rail through a 10k $\Omega$ resistor.
H6	IBAT	AO	Charging current sensing output. It is recommended to connect IBAT pin to the GND through a 10k $\Omega$ /1% resistor for 250mV/A voltage to charging current gain. The maximum voltage at the IBAT pin is clamped at 3.3V.
H7	TS	AI	Temperature qualification voltage input to support JEITA profile. Connect a negative temperature coefficient thermistor (103AT). Program temperature window with a resistor divider from REGN to TS to GND. The resistors used for resistor divider is recommended to be 1% resistance tolerance. Charge suspends when TS pin voltage is out of range. When TS pin is not used, connect a 10k $\Omega$ resistor from REGN to TS and a 10k $\Omega$ resistor from TS to GND.



## System Block Diagram

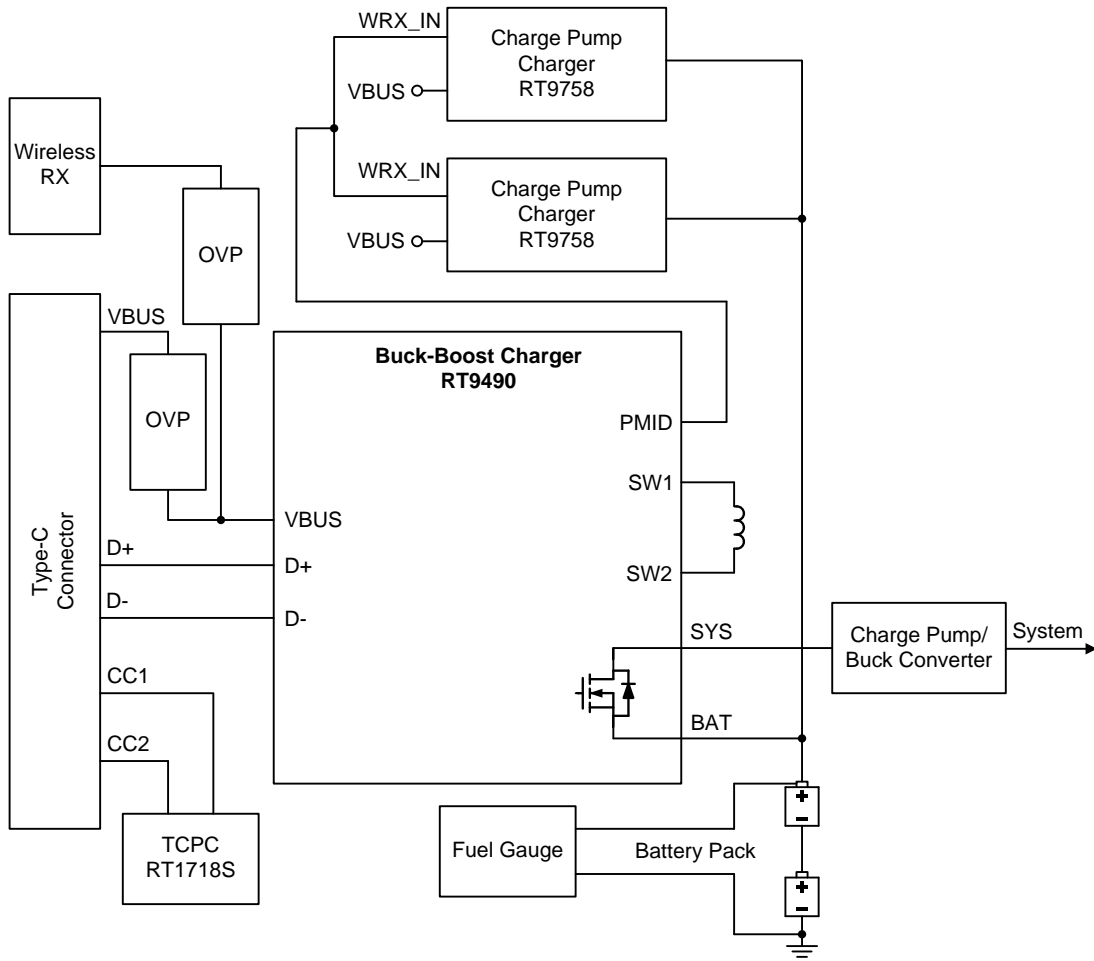

**Absolute Maximum Ratings** (Note 1)

- Voltage Sense Pin Voltage, VAC1, VAC2----- -2V to 30V
- Supply Pin Voltage, VBUS ----- -2V to 30V
- Terminal Pin Voltage, PMID ----- -0.3V to 30V
- Terminal Pin Voltage, ACDRV1, ACDRV2, BTST1 ----- -0.3V to 32V
- Terminal Pin Voltage, BTST2 ----- -0.3V to 29V
- Terminal Pin Voltage, SW1 ----- -2V (50ns) to 30V
- Terminal Pin Voltage, SW2 ----- -2V (50ns) to 23V
- Terminal Pin Voltage, SYS----- -0.3V to 23V
- Supply Pin Voltage, BAT ----- -0.3V to 20V
- Voltage Sense Pin Voltage, B ATP ----- -0.3V to 20V
- Voltage Sense Pin Voltage, BATN ----- -0.3V to 6V
- Terminal Pin Voltage, SDRV ----- -0.3V to 26V
- Terminal Pin Voltage, PMID-VBUS ----- -0.3V to 6V
- Terminal Pin Voltage, BTST1-SW1, BTST2-SW2----- -0.3V to 6V
- Terminal Pin Voltage, SYS-BAT ----- -0.3V to 16V
- Terminal Pin Voltage, SDRV-BAT----- -0.3V to 6V
- Other Pins Voltage, STAT/OTG, SCL, SDA,  $\overline{\text{INT}}$ ,  $\overline{\text{CE}}$ , D+, D-,  $\overline{\text{PG}}$ ----- -0.3V to 6V
- Other Pins Voltage for REGN, TS,  $\overline{\text{QON}}$ , ILIM\_HZ, PROG, IBAT----- -0.3V to 6V
- Power Dissipation, P<sub>D</sub> @ T<sub>A</sub> = 25°C
  - WL-CSP-56B 2.93x3.46 (BSC) ----- 3.31W
- Package Thermal Resistance (Note 2)
  - WL-CSP-56B 2.93x3.46 (BSC),  $\theta_{JA}$  ----- 31.7°C/W
- Lead Temperature (Soldering, 10 sec.)----- 260°C
- Junction Temperature ----- 150°C
- Storage Temperature Range ----- -55°C to 150°C
- ESD Susceptibility (Note 3)
  - HBM (Human Body Model) ----- 2kV

**Recommended Operating Conditions** (Note 4)

- Voltage Sense Pin Voltage, VAC1, VAC2----- 3.6V to 24V
- Supply Input Voltage Range, VBUS ----- 3.6V to 24V
- Maximum Input Current, IBUS ----- 3.3A
- Maximum Input Current, IOTG----- 3.32A
- Maximum Output Current (SW2), ISYS (Note 5)----- 5A
- Maximum Battery Voltage, VBAT ----- 18.8V
- Maximum Charge Current, IBAT ----- 5A
- Maximum Discharge Current, IBAT----- 10A
- Ambient Temperature Range ----- -40°C to 85°C
- Junction Temperature Range ----- -40°C to 130°C

## Electrical Characteristics

( $V_{BUS\_UVLO} < V_{BUS} < V_{BUS\_OVP}$ ,  $T_J = 25^{\circ}C$ , unless otherwise specified)

Parameter	Symbol	Test Conditions	Min	Typ	Max	Unit
<b>Quiescent Current</b>						
Battery Discharge Current (BATP) in Ship Mode	I <sub>Q_BAT_OFF</sub>	BATP = 8V, No VBUS, I <sup>2</sup> C enabled, ADC disabled, SYS no load, in ship mode, measure IBAT	--	2.5	6	μA
Battery Discharge Current (BATP) in Shutdown Mode	I <sub>SD_BAT_OFF</sub>	BATP = 8V, No VBUS, I <sup>2</sup> C disable, ADC disabled, SYS no load, in shutdown mode, measure IBAT	--	0.6	0.9	μA
Battery Discharge Current (BATP, BAT) in the Battery Only Mode, Q5 is Enabled	I <sub>Q_BAT_ON</sub>	VBAT = 8V, No VBUS, Q5 is enabled, I <sup>2</sup> C enabled, ADC disabled, SYS no load, measure IBAT	--	18	23	μA
Battery Discharge Current (BATP, BAT) in the Battery Only Mode, Q5 is Enabled	I <sub>Q_BAT_ADC_ON</sub>	VBAT = 8V, No VBUS, Q5 is enabled, I <sup>2</sup> C enabled, ADC VBAT enabled, SYS no load, measure IBAT	--	650	--	μA
Input Supply Current (VAC) in HZ mode	I <sub>VAC_HZ</sub>	VAC = 5V, HZ mode, no battery, ADC disabled, ACDRV enabled, BC12 disabled	--	500	550	μA
Input Supply Current (VBUS) in HZ mode	I <sub>VBUS_HZ</sub>	VBUS = 5V, HZ mode, no battery, ADC disabled, ACDRV disabled, BC12 disabled	--	354	440	μA
Input Supply Current (VBUS)	I <sub>BUS_SW</sub>	VBUS = 15V, VBAT = 8V, charge disabled, converter switching, ISYS = 0A, OOA disabled	--	3	--	mA
		VBUS = 15V, VBAT = 8V, charge disabled, converter switching, ISYS = 0A, OOA enabled	--	5	--	
Battery Discharge Current (BATP, BAT) in OTG Mode	I <sub>BAT_OTG</sub>	VBAT = 8V, VOTG = 5V, OTG mode enabled, converter switching, IBUS = 0A, OOA disabled	--	2	--	mA
		VBAT = 8V, VOTG = 5V, OTG mode enabled, converter switching, IBUS = 0A, OOA enabled	--	5	--	
<b>VAC, VBUS and BAT Power</b>						
VAC rising threshold to Turn On the ACDRV	V <sub>VAC_RISE</sub>	VAC rising until ACFET turn on, measure VAC, VBUS, ACDRV1 and ACDRV2	--	3.4	3.5	V
VAC falling threshold to Turn Off the ACDRV	V <sub>VAC_FALL</sub>	VAC falling until ACFET turn off, measure VAC, VBUS, ACDRV1 and ACDRV2	3.1	3.2	--	V
VBUS Rising for Active I <sup>2</sup> C, No Battery	V <sub>BUS_UVLO</sub>	VBUS only, VBUS rising to active I <sup>2</sup> C	3.45	3.6	3.75	V



Parameter	Symbol	Test Conditions	Min	Typ	Max	Unit
VBUS Falling to Turn Off I <sup>2</sup> C, No Battery		VBUS only, VBUS falling to turn off I <sup>2</sup> C	--	2.4	2.6	V
VBUS Rising Threshold to Start Switching	VBUS_RISE	VBUS only, VBUS rising	3.45	3.6	3.75	V
VBUS Falling Threshold to Turn off REGN	VBUS_FALL	VBUS only, VBUS falling	3.03	3.2	3.3	V
VAC 26V Overvoltage Rising Threshold	VAC_OVP	VAC rising, VAC_OVP[1:0] = 00, for both VAC1 and VAC2	25.2	26	26.8	V
VAC 26V Overvoltage Falling Threshold		VAC falling, VAC_OVP[1:0] = 00, for both VAC1 and VAC2	24.4	25.2	26	
VAC 22V Overvoltage Rising Threshold		VAC rising, VAC_OVP[1:0] = 01, for both VAC1 and VAC2	21.4	22	22.6	
VAC 22V Overvoltage Falling Threshold		VAC falling, VAC_OVP[1:0] = 01, for both VAC1 and VAC2	20.8	21.4	22	
VAC 12V Overvoltage Rising Threshold		VAC rising, VAC_OVP[1:0] = 10, for both VAC1 and VAC2	11.6	12	12.4	
VAC 12V Overvoltage Falling Threshold		VAC falling, VAC_OVP[1:0] = 10, for both VAC1 and VAC2	11.2	11.6	12	
VAC 7V Overvoltage Rising Threshold		VAC rising, VAC_OVP[1:0] = 11, for both VAC1 and VAC2	6.7	7	7.3	
VAC 7V Overvoltage Falling Threshold		VAC falling, VAC_OVP[1:0] = 11, for both VAC1 and VAC2	6.5	6.8	7.1	
VBUS Overvoltage Rising Threshold	VBUS_OVP	VBUS rising	24.7	25.7	26.2	V
VBUS Overvoltage Falling Threshold		VBUS falling	23.5	24.4	24.8	
IBUS Overcurrent Rising Threshold	IBUS_OCP	IBUS rising	--	8	--	A
BAT for turn on Q5 and Active I <sup>2</sup> C	VBAT_UVLO	VBAT rising	2.5	2.6	2.7	V
BAT for turn off Q5 and I <sup>2</sup> C		VBAT falling	2.3	2.4	2.5	
BATP for turn on Ship FET and Active I <sup>2</sup> C	VBATP_UVLO	VBATP rising	3.3	3.4	3.5	V
BATP for Turn Off I <sup>2</sup> C and Ship FET		VBATP falling	2.3	2.4	2.5	
Bad Adapter Detection Falling Threshold	VBUS_MIN	VBUS falling	3.3	3.4	3.5	V
Bad Adapter Detection Hysteresis	VBUS_MIN_HYS	VBUS rising	150	200	250	mV
Bad Adapter Detection Sink Source	RBADSRC	Sink source from VBUS to GND, VBUS = 5V	--	1.1	--	kΩ

Parameter	Symbol	Test Conditions	Min	Typ	Max	Unit
<b>Power Path</b>						
SYS Minimum Regulation Voltage Setting Range	VSYSMIN_RANGE	VSYSMIN regulation range, measured on SYS	2.5	--	16	V
SYS Minimum Regulation Voltage Step	VSYSMIN_STEP		--	250	--	mV
SYS Minimum Regulation Voltage	VSYSMIN	VBAT < VSYSMIN, Q5 disabled/enable	VSYSMIN	VSYSMIN + 0.2	--	V
SYS Minimum Regulation Voltage Accuracy	VSYSMIN_ACC	VSYSMIN = 7V	-2	--	2	%
SYS Regulation Voltage	VSYSREG	VBAT = 16.8V, VBAT > VSYSMIN, Q5 disabled	17	17.1	17.2	V
		VBAT = 12.6V, VBAT > VSYSMIN, Q5 disabled	12.8	12.9	13	
		VBAT = 8.4V, VBAT > VSYSMIN, Q5 disabled	8.6	8.7	8.8	
VSYS Overvoltage Rising Threshold	VSYS_OVP	As a percentage of the system regulation voltage, the converter stops switching when VSYS rises	107.5	110	112.5	%
VSYS Overvoltage Falling Threshold		As a percentage of the system regulation voltage, the converter re-start switching when VSYS falling	97.5	100	102.5	
VSYS Overvoltage Sink Source	RSYS_OVP	Sink source from VSYS to GND	--	0.85	--	kΩ
VSYS Short Voltage Falling Threshold	VSYS_SHORT	VSYS falling	2.1	2.2	2.3	V
<b>Battery Charger</b>						
Charge Voltage Setting Range	VBAT_REG_RANGE		5	--	18.8	V
Charge Voltage Step	VBAT_REG_STEP		--	10	--	mV
Charge Voltage Setting Accuracy	VBAT_REG_ACC	VBAT_REG = 8.4V	-0.3	--	0.3	%
		VBAT_REG = 12.6V	-0.3	--	0.3	
		VBAT_REG = 16.8V	-0.5	--	0.5	
Charge Current Regulation Setting Range	ICHG_REG_RANGE		150	--	5000	mA
Charge Current Regulation Step	ICHG_REG_STEP		--	10	--	mA

Parameter	Symbol	Test Conditions	Min	Typ	Max	Unit
Charge Current Regulation Accuracy	ICHG_REG_ACC	ICHG_REG = 2A, VSYSMIN = 7V, VBAT = 8V (Note 6)	-3.5	--	3.5	%
		ICHG_REG = 1A, VSYSMIN = 7V, VBAT = 8V	-4	--	4	
		ICHG_REG = 0.5A, VSYSMIN = 7V, VBAT = 8V	-7.5	--	7.5	
Pre-Charge Rising Threshold	VPRE_CHG_RISE	VPRE_CHG = 15% x VBAT_REG, Pre-charge to Fast-charge, VBAT_REG = 18.8V	13	15	17	%
		VPRE_CHG = 62% x VBAT_REG, Pre-charge to Fast-charge, VBAT_REG = 8.4V	60.5	62	63.5	
		VPRE_CHG = 66.5% x VBAT_REG, Pre-charge to Fast- charge, VBAT_REG = 8.4V	65	66.5	68	
		VPRE_CHG = 71.5% x VBAT_REG, Pre-charge to Fast- charge, VBAT_REG = 8.4V	70	71.5	73	
Pre-Charge Hysteresis	VPRE_CHG_HYS	Fast-charge to Pre-charge	--	1.5	--	%
Pre-Charge Current Setting Range	IPRE_CHG_RANGE	Default = 120mA	120	--	2000	mA
Pre-Charge Current Step	IPRE_CHG_STEP		--	40	--	mA
Pre-Charge Accuracy	IPRE_CHG_ACC	IPRE_CHG = 200mA, VSYSMIN = 7V, VBAT = 6.5V	-15	--	15	%
		IPRE_CHG = 120mA, VSYSMIN = 7V, VBAT = 6.5V	-30	--	30	
End-Of-Charge Current Setting Range	IEOC_CHG_RANGE	Default = 200mA	120	--	1000	mA
End-Of-Charge Current Step	IEOC_CHG_STEP		--	40	--	mA
End-Of-Charge Accuracy (Note 7)	IEOC_CHG_ACC	IEOC_CHG = 120mA, DIS_EOC_FCCM = 0 VBUS = 15V, VBAT = 8.4V	-20	--	20	%
		IEOC_CHG = 200mA, DIS_EOC_FCCM = 0 VBUS = 15V, VBAT = 8.4V	-15	--	15	
		IEOC_CHG = 480mA, DIS_EOC_FCCM = 0 VBUS = 15V, VBAT = 8.4V	-10	--	10	
Trickle-Charge Falling Threshold	VTRICKLE_CHG_FALL	VBAT falling	1.8	2	2.2	V
Trickle-Charge Rising Threshold	VTRICKLE_CHG_RISE	VBAT rising	2.05	2.25	2.45	V
Trickle-Charge Current	ITRICKLE_CHG	VBAT < VTRICKLE_CHG_RISE	80	100	120	mA
Re-Charge Threshold Below VBAT_REG	VRE_CHG	VBAT falling, VRECHG = 200mV, VBUS = 15V, VBAT_REG = 8.4V	180	200	230	mV

Parameter	Symbol	Test Conditions	Min	Typ	Max	Unit
<b>Input Voltage and Current Regulation</b>						
Minimum Input Voltage Regulation Setting Range	VMIVR_RANGE		3.6	--	22	V
Minimum Input Voltage Regulation Step	VMIVR_STEP		--	100	--	mV
Minimum Input Voltage Regulation Accuracy	VMIVR_ACC	VMIVR = 4.3V, 10.6V and 18.6V	-1	--	1	%
Average Input Current Regulation Setting Range	IAICR_RANGE		0.1	--	3.3	A
Average Input Current Regulation Step	IAICR_STEP		--	10	--	mA
Average Input Current Regulation Accuracy	IAICR_ACC	V <sub>BUS</sub> = 15V, I <sub>AICR</sub> = 500mA	440	470	500	mA
		V <sub>BUS</sub> = 15V, I <sub>AICR</sub> = 1000mA	900	950	1000	
		V <sub>BUS</sub> = 15V, I <sub>AICR</sub> = 2000mA (Note 6)	1800	1900	2000	
		V <sub>BUS</sub> = 15V, I <sub>AICR</sub> > 2000mA (Note 6)	-9	--	0	%
<b>BAT Overvoltage Protection</b>						
Battery Overvoltage Rising	VBAT_OVP	V <sub>BAT</sub> rising, as percentage of V <sub>BAT_REG</sub>	103	104	105	%
Battery Overvoltage Falling		V <sub>BAT</sub> falling, as percentage of V <sub>BAT_REG</sub>	101	102	103	%
Battery Overvoltage Sink Source	RBAT_OVP	Sink source from V <sub>BAT</sub> to GND	--	1.1	--	kΩ
<b>Thermal Regulation and Shutdown</b>						
Junction Thermal Regulation Setting Range	T <sub>J_THREG_RANGE</sub>	Default = 120°C	60	--	120	°C
Junction Thermal Regulation Step	T <sub>J_THREG_STEP</sub>		--	20	--	°C
Junction Thermal Regulation Accuracy	T <sub>J_THREG_ACC</sub>	T <sub>J_THREG</sub> = 120°C	--	120	--	°C
		T <sub>J_THREG</sub> = 100°C	--	100	--	
		T <sub>J_THREG</sub> = 80°C	--	80	--	
		T <sub>J_THREG</sub> = 60°C	--	60	--	
Thermal Shutdown Rising	T <sub>OTP</sub>	T <sub>J_THREG</sub> = 150°C, Temperature rising (Note 6)	130	150	170	°C
		T <sub>J_THREG</sub> = 130°C, Temperature rising (Note 6)	110	130	150	
		T <sub>J_THREG</sub> = 120°C, Temperature rising (Note 6)	100	120	140	
		T <sub>J_THREG</sub> = 85°C, Temperature rising (Note 6)	65	85	105	

Parameter	Symbol	Test Conditions	Min	Typ	Max	Unit
Thermal Shutdown Hysteresis	TOTP_HYS	Temperature falling	--	30	--	°C
<b>NTC Monitor (Charger Mode)</b>						
Battery Temperature COLD Threshold (0°C)	VVTS_COLD	VTS rising, the ratio of VREGN	72.3	73.5	74.7	%
		VTS falling, the ratio of VREGN	70.8	72	73.2	
Battery Temperature COOL Rising Threshold	VVTS_COOL_RISE	VVTS_COOL = 5°C, VTS rising, the ratio of VREGN (Note 6)	70.6	71.1	71.6	%
		VVTS_COOL = 10°C, VTS rising, the ratio of VREGN	67.4	68.5	69.6	
		VVTS_COOL = 15°C, VTS rising, the ratio of VREGN (Note 6)	65	65.5	66	
		VVTS_COOL = 20°C, VTS rising, the ratio of VREGN (Note 6)	61.9	62.4	62.9	
Battery Temperature COOL Falling Threshold	VVTS_COOL_FALL	VVTS_COOL = 5°C, VTS falling, the ratio of VREGN (Note 6)	69.3	69.8	70.3	%
		VVTS_COOL = 10°C, VTS falling, the ratio of VREGN	65.9	67.0	68.1	
		VVTS_COOL = 15°C, VTS falling, the ratio of VREGN (Note 6)	63.7	64.2	64.7	
		VVTS_COOL = 20°C, VTS falling, the ratio of VREGN (Note 6)	60.6	61.1	61.6	
Battery Temperature WARM Falling Threshold	VVTS_WARM_FALL	VVTS_WARM = 40°C, VTS falling, the ratio of VREGN (Note 6)	47.9	48.4	48.9	%
		VVTS_WARM = 45°C, VTS falling, the ratio of VREGN	44.2	45	45.8	
		VVTS_WARM = 50°C, VTS falling, the ratio of VREGN (Note 6)	40.7	41.2	41.7	
		VVTS_WARM = 55°C, VTS falling, the ratio of VREGN (Note 6)	37.2	37.7	38.2	
Battery Temperature WARM Rising Threshold	VVTS_WARM_RISE	VVTS_WARM = 40°C, VTS rising, the ratio of VREGN (Note 6)	49.2	49.7	50.2	%
		VVTS_WARM = 45°C, VTS rising, the ratio of VREGN	45.2	46	46.8	
		VVTS_WARM = 50°C, VTS rising, the ratio of VREGN (Note 6)	42	42.5	43	
		VVTS_WARM = 55°C, VTS rising, the ratio of VREGN (Note 6)	38.5	39	39.5	
Battery Temperature HOT Threshold (60°C)	VVTS_HOT	VTS falling, the ratio of VREGN	33.4	34	34.6	%
		VTS rising, the ratio of VREGN	34.9	35.5	36.1	
<b>NTC Monitor (OTG Mode)</b>						
Battery Temperature COLD Rising Threshold OTG Mode	VVTS_COLD_OTG_RISE	VVTS_COLD_OTG = -20°C, VTS rising, the ratio of VREGN (Note 6)	78.7	80	81.3	%
		VVTS_COLD_OTG = -10°C, VTS rising, the ratio of VREGN	75.7	77	78.3	

Parameter	Symbol	Test Conditions	Min	Typ	Max	Unit
Battery Temperature COLD Falling Threshold OTG Mode	VVTS_COLD_OTG_F ALL	VVTS_COLD_OTG = -20°C, VTS falling, the ratio of VREGN (Note 6)	78.2	78.7	79.2	%
		VVTS_COLD_OTG = -10°C, VTS falling, the ratio of VREGN	74.8	76	77.2	
Battery Temperature HOT Falling Threshold OTG Mode	VVTS_HOT_OTG_ FALL	VVTS_HOT_OTG = 55°C, VTS falling, the ratio of VREGN (Note 6)	37.2	37.7	38.2	%
		VVTS_HOT_OTG = 60°C, VTS falling, the ratio of VREGN	33.9	34.5	35.1	
		VVTS_HOT_OTG = 65°C, VTS falling, the ratio of VREGN (Note 6)	32	32.5	33	
Battery Temperature HOT Rising Threshold OTG Mode	VVTS_HOT_OTG_ RISE	VVTS_HOT_OTG = 55°C, VTS rising, the ratio of VREGN (Note 6)	38.8	39.3	39.8	%
		VVTS_HOT_OTG = 60°C, VTS rising, the ratio of VREGN	34.9	35.5	36.2	
		VVTS_HOT_OTG = 65°C, VTS rising, the ratio of VREGN (Note 6)	32	32.5	33	
<b>Overcurrent Threshold</b>						
Q1 Cycle-by-Cycle Overcurrent Threshold	I <sub>OCP_Q1</sub>		8.55	10.5	12.25	A
Q2 Cycle-by-Cycle Overcurrent Threshold	I <sub>OCP_Q2</sub>		6.8	7.5	8.25	A
Q3 Cycle-by-Cycle Overcurrent Threshold	I <sub>OCP_Q3</sub>		6.8	7.5	8.25	A
Q4 Cycle-by-Cycle Overcurrent Threshold	I <sub>OCP_Q4</sub>		8.55	10.5	12.25	A
System Over-Load Threshold	I <sub>OCP_BATFET</sub>		11	--	--	A
<b>Internal Sense Resistance and MOSFET R<sub>dson</sub></b>						
Reverse-Blocking MOSFET (QRB) Turn on Resistance between VBUS and PMID	R <sub>ON_QRB</sub>		--	9	--	mΩ
High-Side Switching MOSFET (Q1) Turn on Resistance between PMID and SW1	R <sub>ON_Q1</sub>	V <sub>REGN</sub> = 4.9V	--	25	--	mΩ
Low-Side Switching MOSFET (Q2) Turn on Resistance between SW1 and PGND	R <sub>ON_Q2</sub>	V <sub>REGN</sub> = 4.9V	--	34	--	mΩ

Parameter	Symbol	Test Conditions	Min	Typ	Max	Unit
Low-Side Switching MOSFET(Q3) Turn on Resistance between SW2 and PGND	RON_Q3	VREGN = 4.9V	--	28	--	mΩ
High-Side Switching MOSFET(Q4) Turn on Resistance between SW2 and SYS	RON_Q4	VREGN = 4.9V	--	17	--	mΩ
BATFET (Q5) Turn on Resistance between SYS and BAT	RON_Q5		--	9	--	mΩ
<b>USB On-The-Go (OTG)</b>						
OTG Low Battery Protection	VOTG_LBP	VBAT falling	2.3	2.5	2.6	V
		VBAT rising	2.5	2.7	2.9	
OTG Voltage Limit Regulation Setting Range	VOTG_CV_RANGE	Default = 5V	2.8	--	22	V
OTG Voltage Limit Regulation Step	VOTG_CV_STEP		--	10	--	mV
OTG Voltage Limit Regulation Accuracy	VOTG_CV_ACC	IVBUS = 0A, VOTG_REG = 5V	-1.5	--	1.5	%
OTG Current Limit Regulation Setting Range	IOTG_CC_RANGE	Default = 3A	0.12	--	3.32	A
OTG Current Limit Regulation Step	IOTG_CC_STEP		--	40	--	mA
OTG Current Limit Regulation Accuracy	IOTG_CC	IOTG_CC = 3A, VBAT = 8V, VOTG_CV = 5V	-3	--	3	%
		IOTG_CC = 1A, VBAT = 8V, VOTG_CV = 5V	-3	--	3	
		IOTG_CC = 0.48A, VBAT = 8V, VOTG_CV = 5V	-10	--	10	
Battery Current Regulation in OTG Mode	IOTG_BAT	IBAT_REG = 3A, VBAT = 8V, VOTG_CV = 5V	2.8	3	3.2	A
		IBAT_REG = 4A, VBAT = 8V, VOTG_CV = 5V	3.8	4	4.2	
		IBAT_REG = 5A, VBAT = 8V, VOTG_CV = 5V	4.8	5	5.2	
OTG Overvoltage Threshold	VOTG_OVP	As percentage of VOTG_CV, OTG mode, OOA disabled, VBUS rising	104	113	120	%
		As percentage of VOTG_CV, OTG mode, OOA disabled, VBUS falling	90	98	104	
OTG Undervoltage Falling Threshold	VOTG_UVP	VBUS falling	2.1	2.2	2.3	V

Parameter	Symbol	Test Conditions	Min	Typ	Max	Unit
<b>PWM</b>						
PWM Switching Frequency	fsw	Oscillator frequency, VBUS = 5V/15V, VBAT = 8V, fsw = 1.5MHz	1.3	1.5	1.7	MHz
		Oscillator frequency, VBUS = 5V/15V, VBAT = 8V, fsw = 750kHz	650	750	850	kHz
<b>REGN</b>						
REGN LDO Output Voltage	VREGN	VBUS = 5V, VBAT = 8V, IREGN= 20mA, measure VREGN	4.6	4.9	5	V
		VBUS = 15V, VBAT = 8V, IREGN= 20mA, measure VREGN	4.6	4.9	5.2	
REGN LDO Current Limit	I <sub>REGN</sub>	VBUS = 5V, VBAT = 8V, VREGN = 4.5V	30	--	--	mA
<b>Current Sense and Sink</b>						
IBAT Pin Current Sensing Accuracy	IBATPIN_ACC	IBAT = 4A, VBAT = 8V	-5	--	5	%
		IBAT = 1A, VBAT = 8V	-10	--	10	
		IBAT = 0.5A, VBAT = 8V	-20	--	20	
VAC1 Discharge Resistance	RVAC1_DISCHG	VAC1_PD_EN = 1, VAC1 = 5V	--	1.1	--	kΩ
VAC2 Discharge Resistance	RVAC2_DISCHG	VAC2_PD_EN = 1, VAC2 = 5V	--	1.1	--	kΩ
VBUS Discharge Resistance	RVBUS_DISCHG	VBUS_PD_EN = 1, VBUS = 5V	--	1.1	--	kΩ
<b>I<sup>2</sup>C Interface (SCL and SDA)</b>						
Input SDA High Threshold Voltage	V <sub>IH_SDA</sub>	Pull high to 1.8V/1.2V	0.84	--	--	V
Input SDA Low Threshold Voltage	V <sub>IL_SDA</sub>	Pull high to 1.8V/1.2V	--	--	0.4	V
Output SDA Low Threshold Voltage	V <sub>OL_SDA</sub>	Sink current = 5mA	--	--	0.4	V
High Level SDA Leakage Current	I <sub>BIAS_SDA</sub>	Pull high to 1.8V	--	--	1	μA
Input SCL High Threshold Voltage	V <sub>IH_SCL</sub>	Pull high to 1.8V/1.2V	0.84	--	--	V
Input SCL Low Threshold Voltage	V <sub>IL_SCL</sub>	Pull high to 1.8V/1.2V	--	--	0.4	V
High Level SCL Leakage Current	I <sub>BIAS_SCL</sub>	Pull high to 1.8V	--	--	1	μA
SCL Clock Frequency	f <sub>SCL</sub>		--	--	3400	kHz
<b>Control I/O Pin (CE, QON and ILIM_HZ)</b>						
Input $\overline{CE}$ High Threshold Voltage	V <sub>IH_CE</sub>		1.3	--	--	V
Input $\overline{CE}$ LOW Threshold Voltage	V <sub>IL_CE</sub>		--	--	0.4	V



Parameter	Symbol	Test Conditions	Min	Typ	Max	Unit
High Level $\overline{CE}$ Leakage Current	I <sub>BIAS_CE</sub>	Pull high to 1.8V	--	--	1	μA
Input $\overline{QON}$ High Threshold Voltage	V <sub>IH_QON</sub>		1.3	--	--	V
Input $\overline{QON}$ LOW Threshold Voltage	V <sub>IL_QON</sub>		--	--	0.4	V
Internal $\overline{QON}$ Pull Up Voltage	V <sub>QON</sub>		2.8	3.1	3.4	V
Internal $\overline{QON}$ Pull Up Resistance	R <sub>QON</sub>		185	200	230	kΩ
Input ILIM_HZ High Threshold Voltage	V <sub>IH_ILIM_HZ</sub>		1	--	--	V
Input ILIM_HZ Low Threshold Voltage	V <sub>IL_ILIM_HZ</sub>		--	--	0.75	V
High Level LIM <sub>ILIM_HZ</sub> Leakage Current	I <sub>BIAS_ILIM_HZ</sub>	V <sub>ILIM_HIZ</sub> = 4V	-1.5	--	1.5	μA
<b>Control I/O Pin (<math>\overline{PG}</math>, <math>\overline{INT}</math> and STAT/OTG)</b>						
Output $\overline{INT}$ Low Threshold Voltage	V <sub>OL_INT</sub>	Sink current = 5mA	--	--	0.4	V
High Level $\overline{INT}$ Leakage Current	I <sub>BIAS_INT</sub>	Pull high to 1.8V	--	--	1	μA
$\overline{INT}$ Pull Low Time	t <sub>INT_PULL_LOW</sub>	$\overline{INT}$ pull low time	--	256	--	μs
Output $\overline{PG}$ Low Threshold Voltage	V <sub>OL_PG</sub>	Sink current = 5mA	--	--	0.4	V
High Level $\overline{PG}$ Leakage Current	I <sub>BIAS_PG</sub>	Pull high to 1.8V	--	--	1	μA
Output STAT/OTG Low Threshold Voltage	V <sub>OL_STAT</sub>	Sink current = 5mA	--	--	0.4	V
High Level STAT/OTG Leakage Current	I <sub>BIAS_STAT</sub>	Pull high to 1.8V	--	--	1	μA
Input STAT/OTG High Threshold Voltage	V <sub>IH_OTG</sub>	STAT configure to OTG pin	1.3	--	--	V
Input STAT/OTG LOW Threshold Voltage	V <sub>IL_OTG</sub>	STAT configure to OTG pin	--	--	0.4	V
<b>D+/D- Detection</b>						
Data Detect Voltage	V <sub>DAT_REF</sub>	For primary/secondary detection	340	375	400	mV
D+ Current Sink	I <sub>D+_ISNK</sub>	V <sub>D+</sub> = 500mV	25	45	65	μA
D- Current Sink	I <sub>D-_ISNK</sub>	V <sub>D-</sub> = 500mV	25	45	65	μA
D+/ D- Leakage Current	I <sub>D+D-_LKG</sub>	HIZ mode	-1	--	1	μA
D+ Logic Threshold	V <sub>LG<sub>C</sub></sub>	V <sub>D+</sub> rising	800	900	1000	mV
D+ Current Source	I <sub>D+_SRC</sub>	V <sub>D+</sub> = 200mV	7	10	13	μA
D+ Voltage Source	V <sub>D+_SRC</sub>		600	650	700	mV
D- Voltage Source	V <sub>D-_SRC</sub>		600	650	700	mV

Parameter	Symbol	Test Conditions	Min	Typ	Max	Unit
D+ Pull Down for Connection Check	RD+_19K		16	20	24	k $\Omega$
D- Pull Down for Connection Check	RD-_19K		16	20	24	k $\Omega$
D+D- Threshold for Non-Standard Adapter (0.9V)	VD+D-_0P9		0.81	0.9	0.99	V
D+D- Threshold for Non-Standard Adapter (1.5V)	VD+D-_1P5		1.4	1.5	1.6	V
D+D- Threshold for Non-Standard Adapter (2.3V)	VD+D-_2P3		2.2	2.3	2.4	V
D+D- Threshold for CDP	VD+D-_CDP	For host mode, CDP	1.8	2	2.2	V
Across D+/D- Resistance in DCP	RDCP	For host mode, DCP	--	50	150	$\Omega$
<b>ADC Measurement</b>						
Effective Resolution	ADCRES	ADC 16 bits	14	15	--	bits
Conversion-Time	tADC_CONV		--	3.6	--	ms
ADC VBUS Voltage Reading Range	VBUS_ADC_RANGE		0	--	30	V
ADC VBUS Voltage Reading Resolution	VBUS_ADC_RES	LSB	--	1	--	mV
ADC VBUS Voltage Reading Accuracy	VBUS_ADC_ACC	VBUS = 3.6V to 24V	-100	--	100	mV
ADC IBUS Current Reading Range	IBUS_ADC_RANGE		0	--	5	A
ADC IBUS Current Reading Resolution	IBUS_ADC_RES	LSB	--	1	--	mA
ADC IBUS Current Reading Accuracy	IBUS_ADC_ACC	IBUS = 0.5A to 1A	-100	--	100	mA
ADC VAC1 Voltage Reading Range	VAC1_ADC_RANGE		0	--	30	V
ADC VAC1 Voltage Reading Resolution	VAC1_ADC_RES	LSB	--	1	--	mV
ADC VAC1 Voltage Reading Accuracy	VAC1_ADC_ACC	VAC1 = 3.6V to 24V	-100	--	100	mV
ADC VAC2 Voltage Reading Range	VAC2_ADC_RANGE		0	--	30	V
ADC VAC2 Voltage Reading Resolution	VAC2_ADC_RES	LSB	--	1	--	mV
ADC VAC2 Voltage Reading Accuracy	VAC2_ADC_ACC	VAC2 = 3.6V to 24V	-100	--	100	mV
ADC VSYS Voltage Reading Range	VSYS_ADC_RANGE		0	--	23	V
ADC VSYS Voltage Reading Resolution	VSYS_ADC_RES	LSB	--	1	--	mV

Parameter	Symbol	Test Conditions	Min	Typ	Max	Unit
ADC VSYS Voltage Reading Accuracy	VSYS_ADC_ACC	VSYS = 2.5V to 13V	-75	--	75	mV
ADC VBAT Voltage Reading Range	VBAT_ADC_RANGE		0	--	20	V
ADC VBAT Voltage Reading Resolution	VBAT_ADC_RES	LSB	--	1	--	mV
ADC VBAT Voltage Reading Accuracy	VBAT_ADC_ACC	VBAT = 2V to 12.6V	-100	--	100	mV
ADC IBAT Current Reading Range	IBAT_ADC_RANGE		0	--	8	A
ADC IBAT Current Reading Resolution	IBAT_ADC_RES	LSB	--	1	--	mA
ADC IBAT Current Reading Accuracy	IBAT_ADC_ACC	IBAT = 0.5A to 1A	-100	--	100	mA
ADC TS Reading Range	RATIO_TS_ADC_RANGE	Ratio for V <sub>TS</sub> /V <sub>REGN</sub>	0	--	99.9	%
ADC TS Reading Resolution	RATIO_TS_ADC_RES	LSB	--	0.098	--	%
ADC TS Reading Accuracy	RATIO_TS_ADC_ACC	V <sub>TS</sub> = 0.1V to 4.7V	-1.568	--	1.568	%
ADC Die Temperature Reading Range	TDIE_ADC_RANGE		-40	--	150	°C
ADC Die Temperature Reading Resolution	TDIE_ADC_RANGE	LSB	--	1	--	°C
ADC Die Temperature Reading Accuracy	TDIE_ADC_ACC	T <sub>J</sub> = 0°C to 85°C	-5	--	5	°C
ADC D+ Voltage Reading Range	VD+_ADC_RANGE		0	--	3600	mV
ADC D+ Voltage Reading Resolution	VD+_ADC_RES	LSB	--	1	--	mV
ADC D+ Voltage Reading Accuracy	VD+_ADC_ACC	D+ = 0V to 3.6V, HZ mode	-18	--	18	mV
ADC D- Voltage Reading Range	VD-_ADC_RANGE		0	--	3600	mV
ADC D- Voltage Reading Resolution	VD-_ADC_RES	LSB	--	1	--	mV
ADC D- Voltage Reading Accuracy	VD-_ADC_ACC	D- = 0V to 3.6V, HZ mode	-18	--	18	mV
<b>Timing Requirements</b>						
Charge Safe Timer for Trickle Charge	t <sub>TRI_SAFE_TMR</sub>		0.9	1	1.1	hr
Charge Safe Timer for Pre-Charge	t <sub>PRE_SAFE_TMR</sub>	PRECHG_TMR = 2hrs	1.8	2	2.2	hr
Charge Safe Timer for Fast Charge	t <sub>CHG_SAFE_TMR</sub>	FASTCHG_TMR = 5hrs	4.5	5	5.5	hr
		FASTCHG_TMR = 8hrs	7.2	8	8.8	

Parameter	Symbol	Test Conditions	Min	Typ	Max	Unit
		FASTCHG_TMR = 12hrs	10.8	12	13.2	
		FASTCHG_TMR = 24hrs	21.6	24	26.4	
Back-Ground Charge Timer	tBG_CHG_TMR	BG_CHG_TMR = 15mins	12	15	18	min
		BG_CHG_TMR = 30mins	24	30	36	
		BG_CHG_TMR = 45mins	36	45	54	
<b>Watchdog Timer</b>						
Watchdog Timer	tWDT	WATCHDOG = 160s	144	160	176	s

**Note 1.** Stresses beyond those listed under “Absolute Maximum Ratings” may cause permanent damage to the device. These are stress ratings only, and functional operation of the device at these or any other conditions beyond those indicated in the operational sections of the specifications is not implied. Exposure to absolute maximum rating conditions may affect device reliability.

**Note 2.**  $\theta_{JA}$  is measured under natural convection (still air) at  $T_A = 25^\circ\text{C}$  with the component mounted on a high effective-thermal-conductivity four-layer test board on a JEDEC 51-7 thermal measurement standard.

**Note 3.** Devices are ESD sensitive. Handling precautions are recommended.

**Note 4.** The device is not guaranteed to function outside its operating conditions.

**Note 5.** Maximum Output Current for ISYS recommend to set switching frequency on 1MHz.

**Note 6.** Specification is guaranteed by design and/or correlation with statistical process control.

**Note 7.** Refer to application note with MIVR topic for detail description.

**Typical Application Circuit**

**RT9490 with Dual Input and Ship FET**

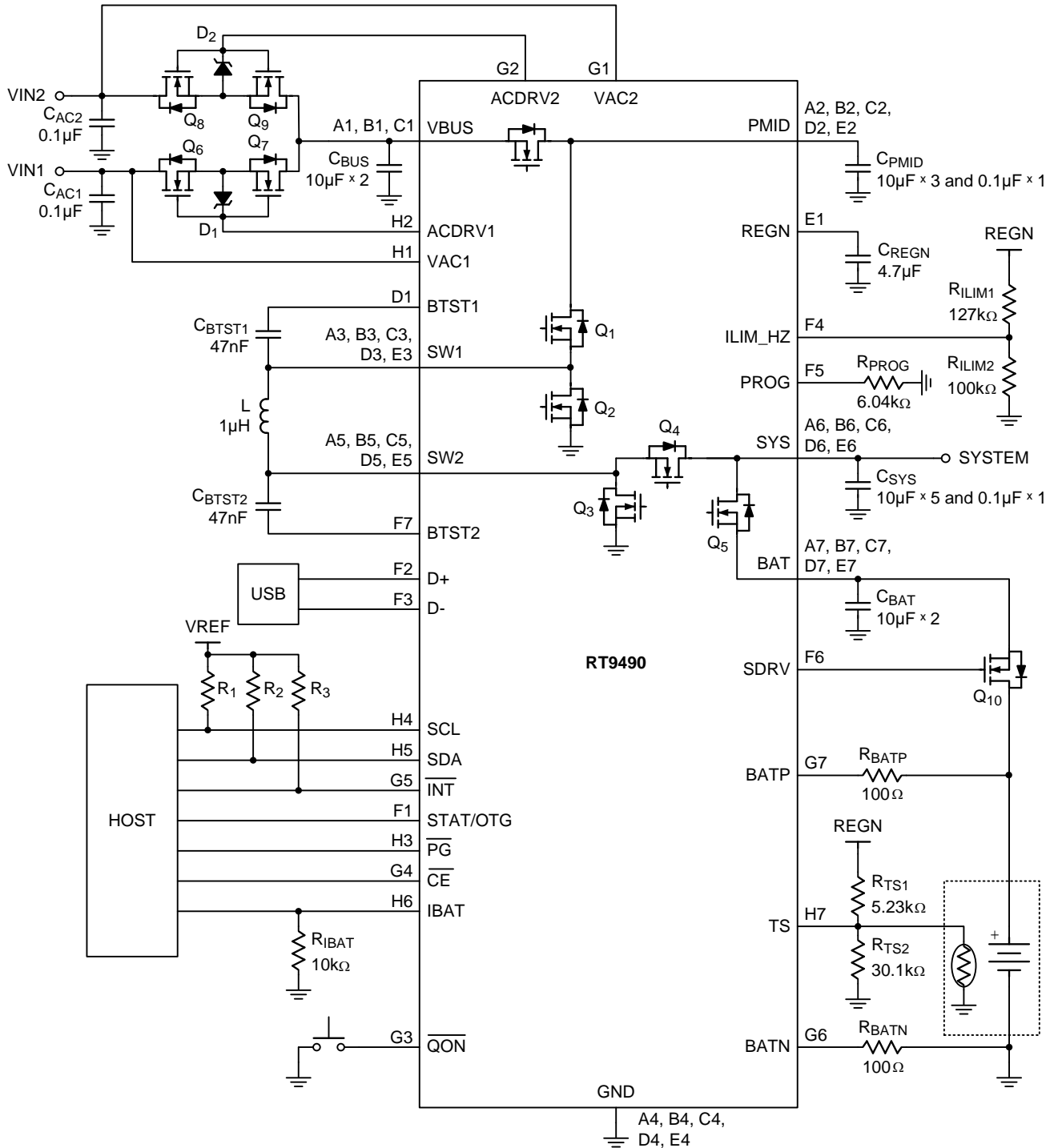

## RT9490 with Single Input and No Ship FET

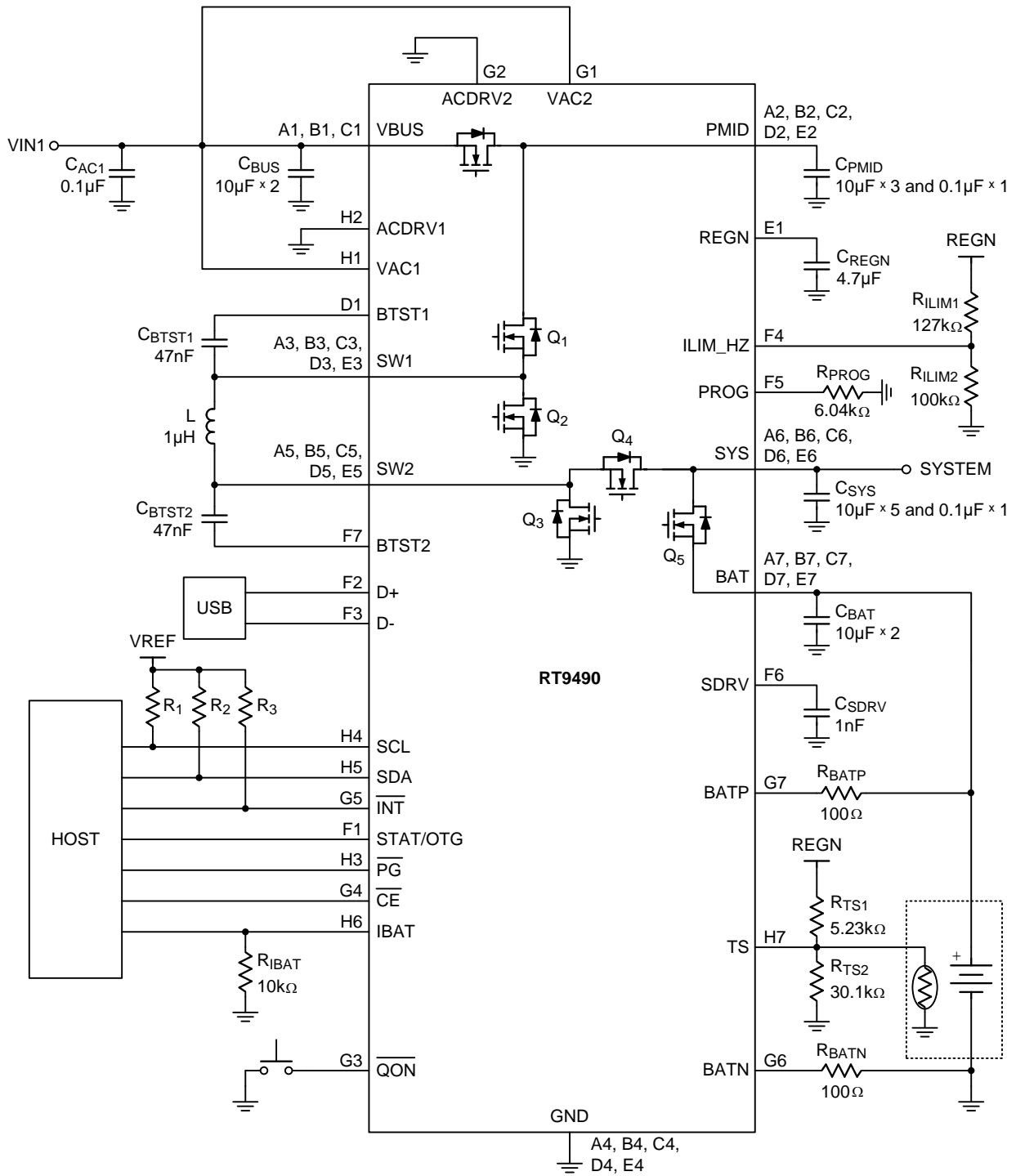

RT9490 with Single ACRBFET and No Ship FET

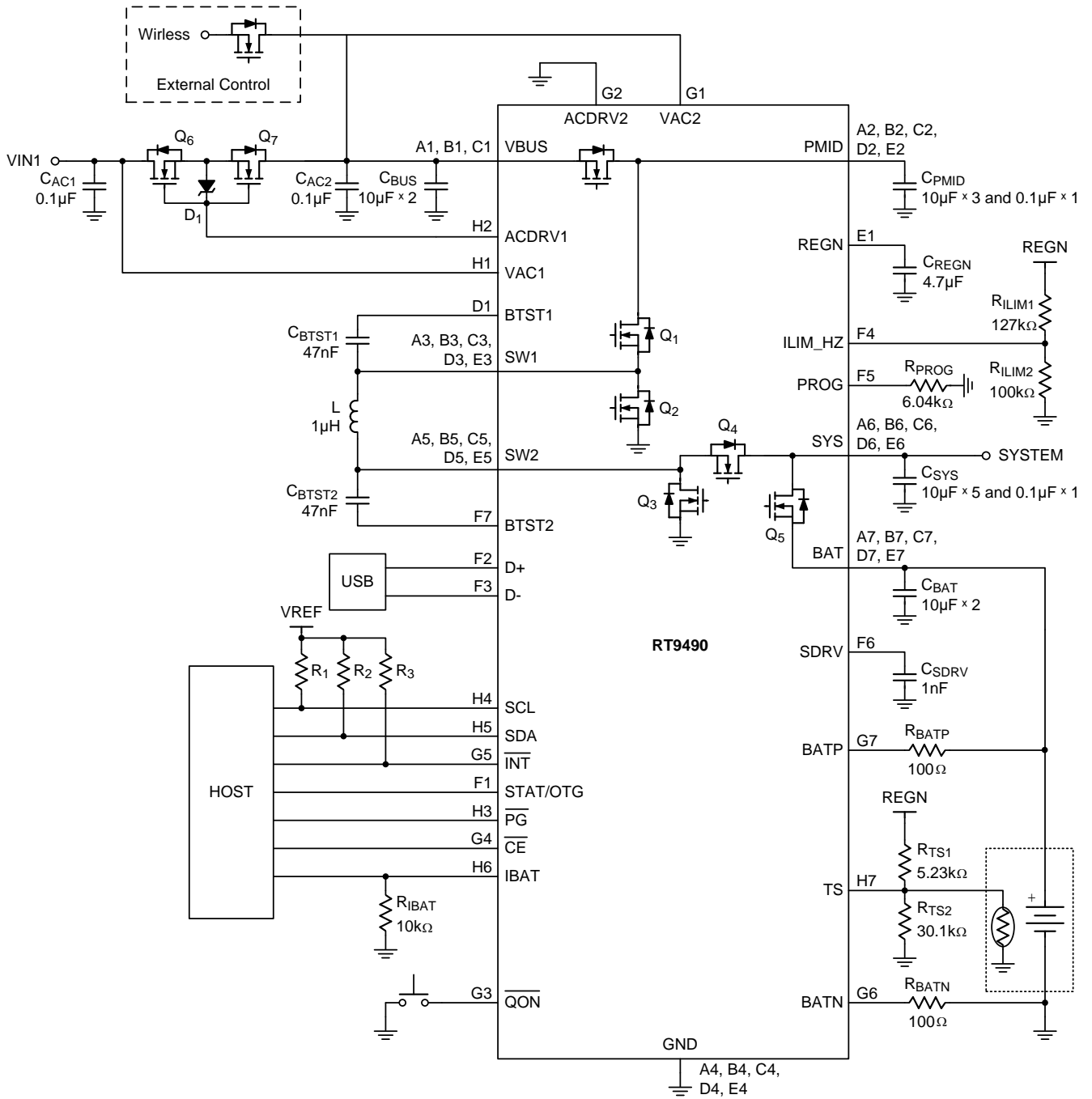

Below are recommended components information

Name	Part Number	Description	Package	Manufacturer
CAC1	0402B104K500CT	0.1 $\mu$ F/50V/X7R	0402	WALSIN
CAC2	0402B104K500CT	0.1 $\mu$ F/50V/X7R	0402	WALSIN
CBUS	GRM188R6YA106MA73	10 $\mu$ F/35V/X5R	0603	MURATA
CPMID	GRM188R6YA106MA73	10 $\mu$ F/35V/X5R	0603	MURATA
CPMID	0402B104K500CT	0.1 $\mu$ F/50V/X7R	0402	WALSIN
CBTST1	GRM033R61C473KE84	47nF/16V/X5R	0201	MURATA
CBTST2	GRM033R61C473KE84	47nF/16V/X5R	0201	MURATA
CSYS	GRM188R61E106MA73	10 $\mu$ F/25V/X5R	0603	MURATA
CSYS	0402B104K500CT	0.1 $\mu$ F/50V/X7R	0402	WALSIN
CBAT	GRM188R61E106MA73	10 $\mu$ F/25V/X5R	0603	MURATA
CREGN	GRM155R60J475ME47D	4.7 $\mu$ F/6.3V/X5R	0402	MURATA
L	PIMB063T-1R0MS-68	1 $\mu$ H/20%/6.7m $\Omega$	6.8x7.3x3.0mm	CYNTEC
	PIMB063T-2R2MS-68	2.2 $\mu$ H/20%/13.5m $\Omega$	6.8x7.3x3.0mm	CYNTEC
Q6, Q7, Q8, Q9	AONR36366	N-MOSFET	DFN 3x3 EP	ALPHA and OMEGA
Q10	AON7528	N-MOSFET	DFN 3.3x3.3 EP	ALPHA and OMEGA



**Typical Operating Characteristics**

**Charger Efficiency vs. Charge Current  
(2s Battery)**

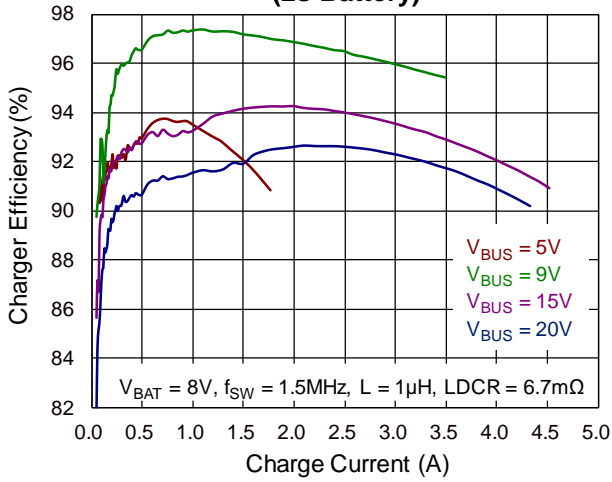

**Charger Efficiency vs. Charge Current  
(3s Battery)**

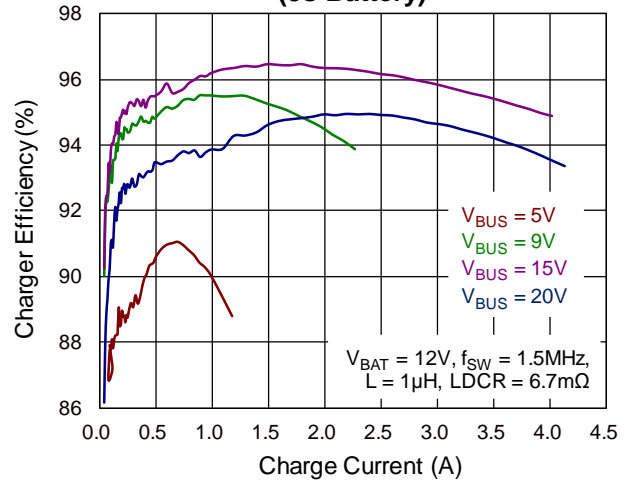

**Charger Efficiency vs. Charge Current  
(4s Battery)**

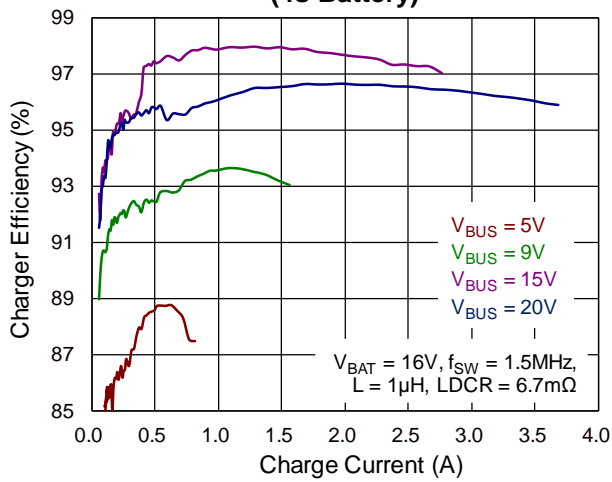

**Charger Efficiency vs. Charge Current  
(2s Battery)**

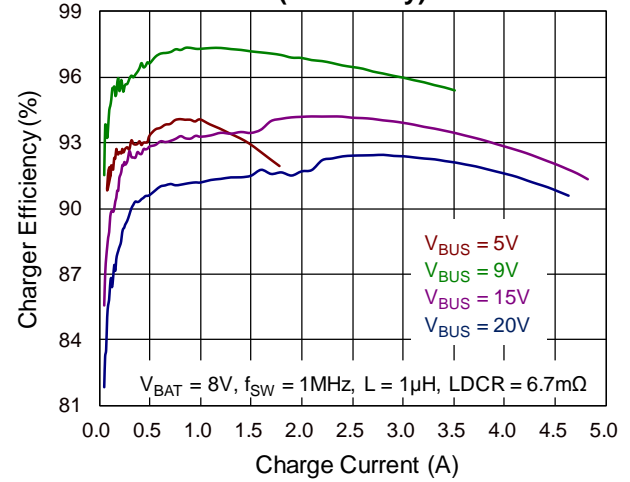

**Charger Efficiency vs. Charge Current  
(3s Battery)**

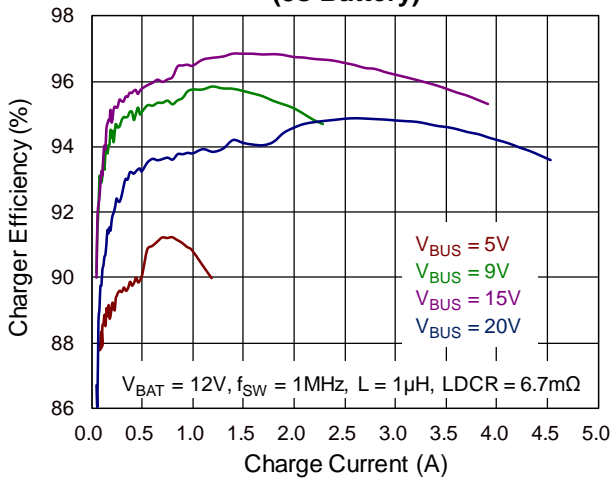

**Charger Efficiency vs. Charge Current  
(4s Battery)**

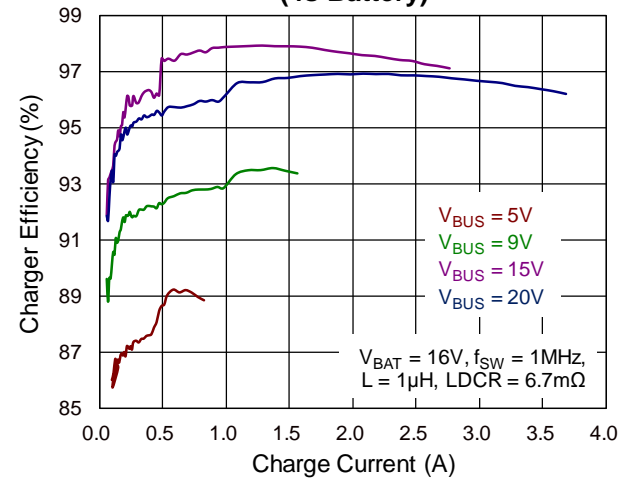

**Charger Efficiency vs. Charge Current (2s Battery)**

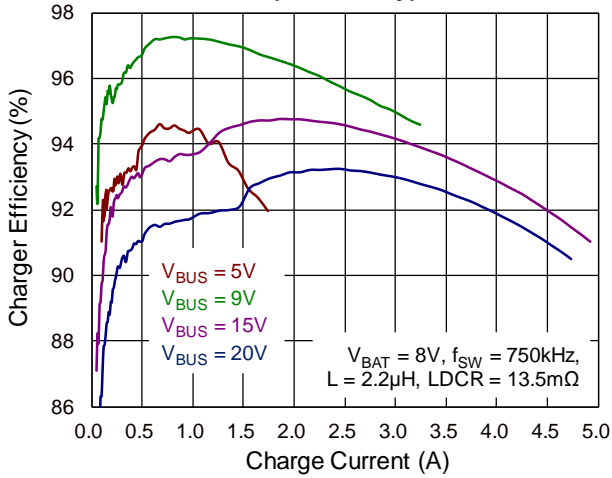

**Charger Efficiency vs. Charge Current (3s Battery)**

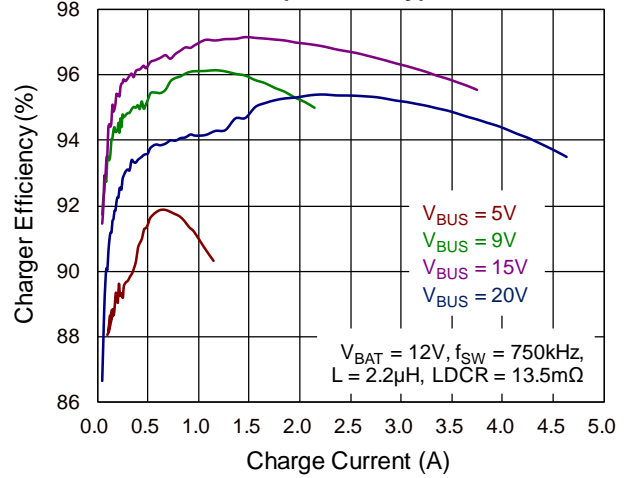

**Charger Efficiency vs. Charge Current (4s Battery)**

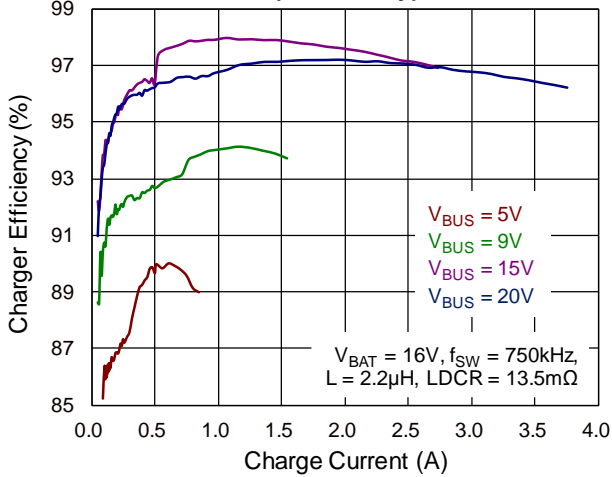

**OTG Efficiency vs. Output Current (2s Battery)**

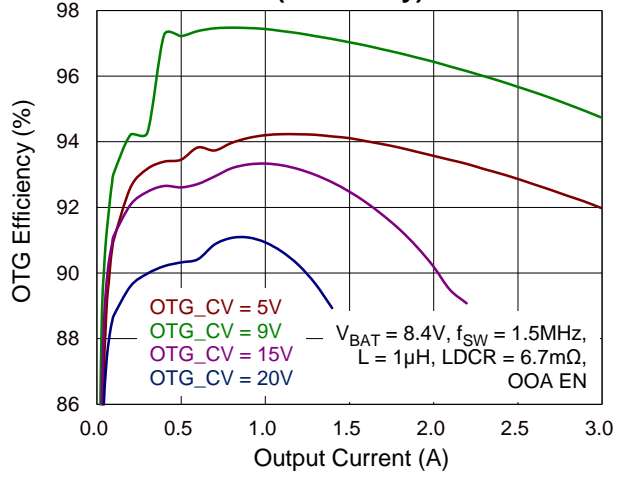

**OTG Efficiency vs. Output Current (3s Battery)**

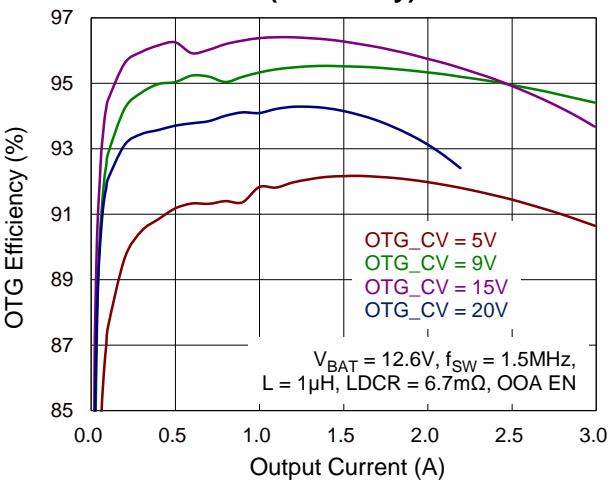

**OTG Efficiency vs. Output Current (4s Battery)**

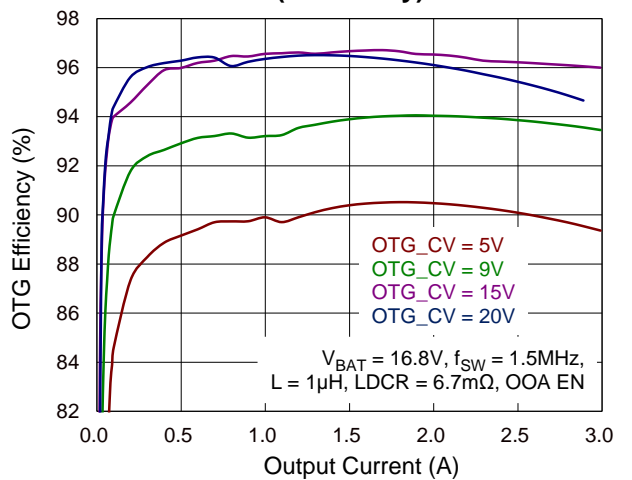

**OTG Efficiency vs. Output Current (2s Battery)**

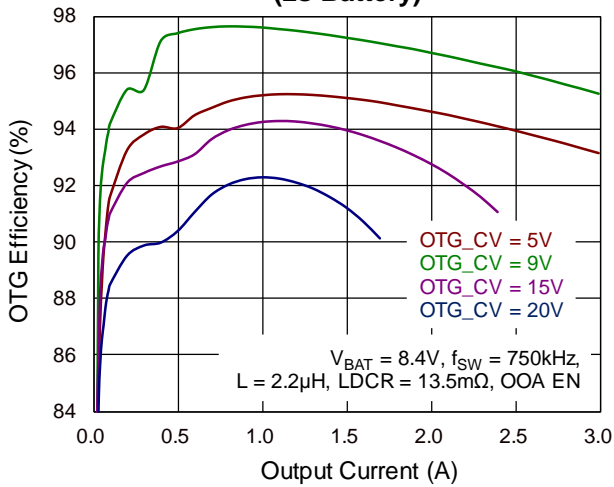

**OTG Efficiency vs. Output Current (3s Battery)**

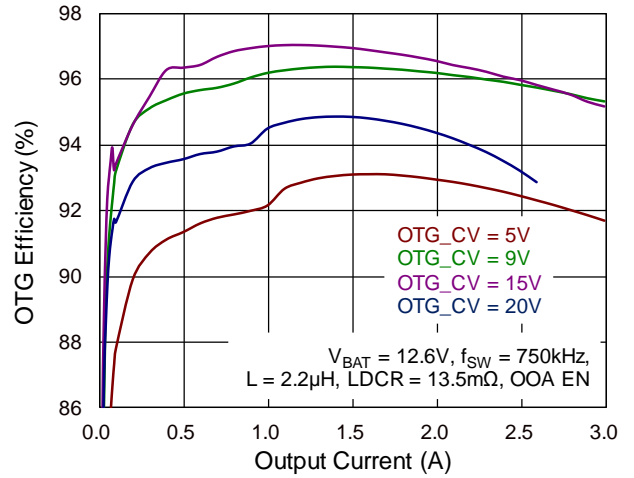

**OTG Efficiency vs. Output Current (4s Battery)**

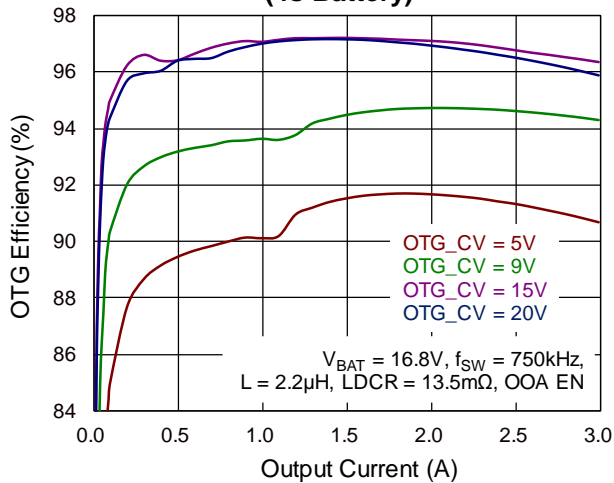

**Power-UP with AC\_RB1, VAC1 Plug in**

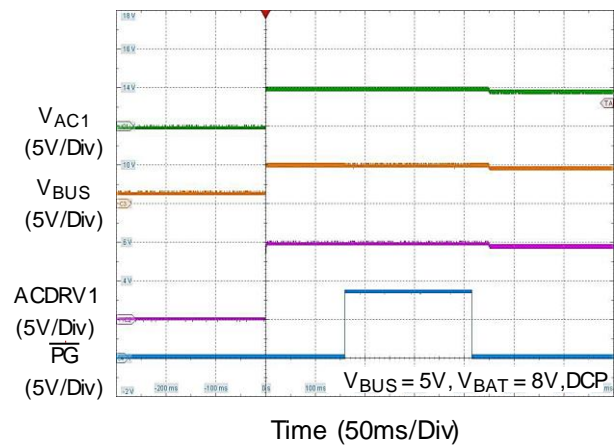

**Power-UP with Singal Input, VBUS Plug in**

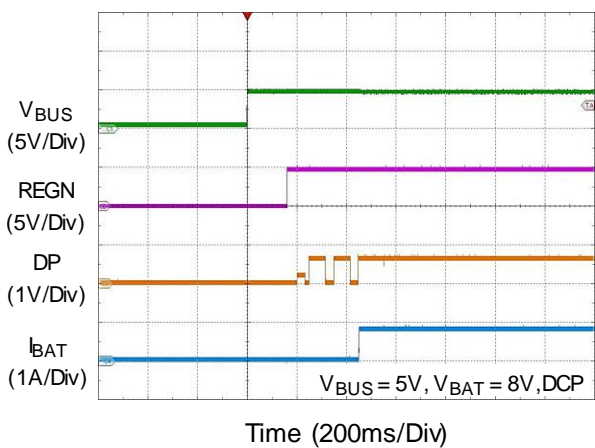

**Charger Enabled**

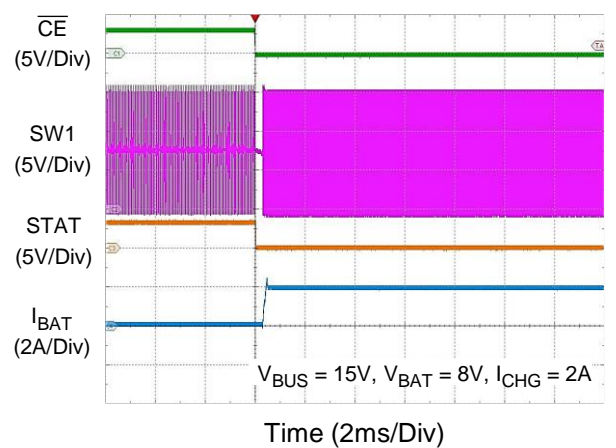

### Charger Disabled

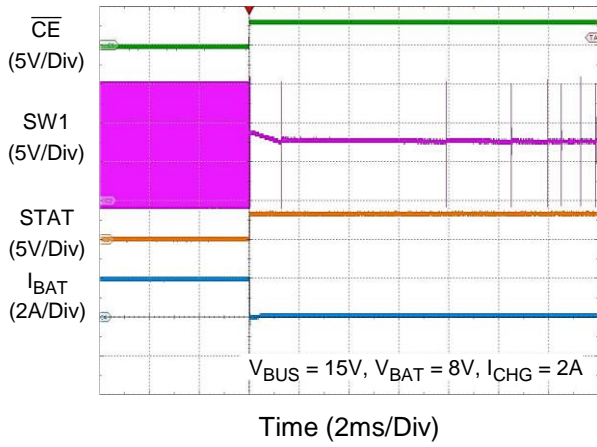

### Charger Disabled, OOA Enabled

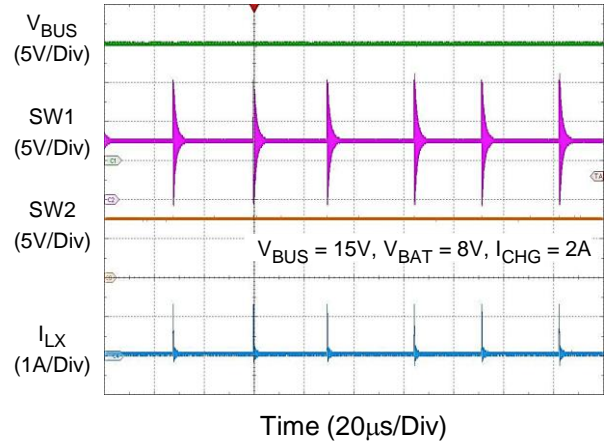

### Charger Disabled, OOA Disabled

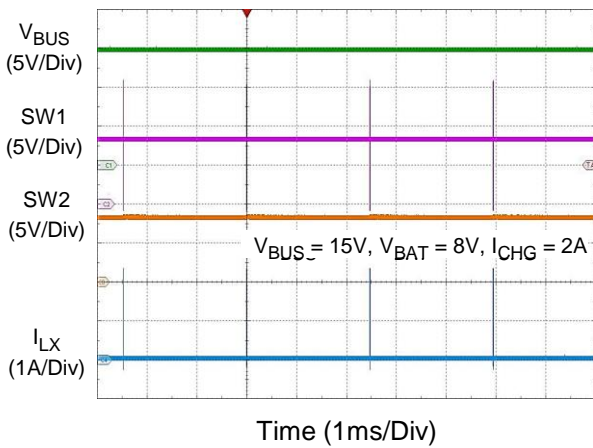

### Boost Mode, Charger Enabled

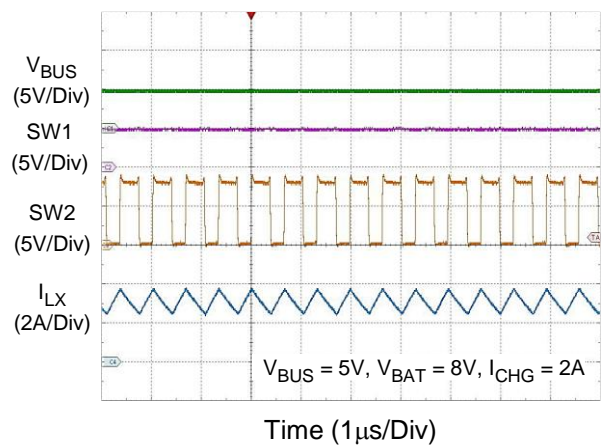

### Buck-Boost Mode, Charger Enabled

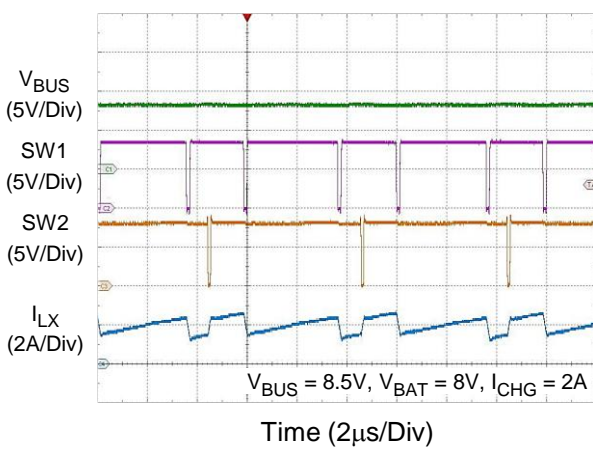

### Buck Mode, Charger Enabled

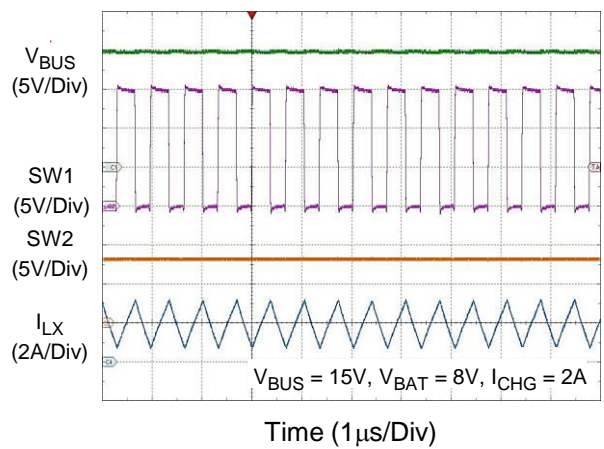

**System Load Transient, Charger Disabled**

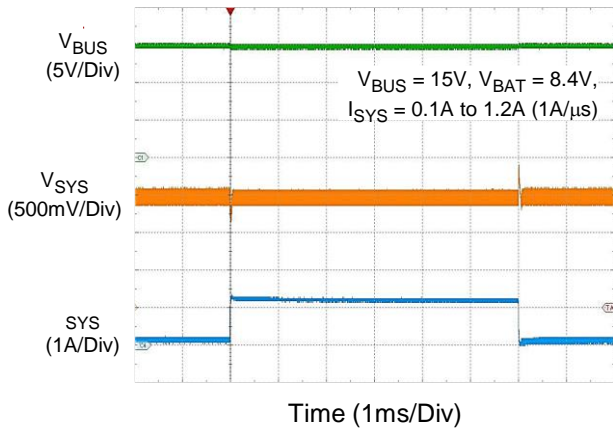

**OTG Load Transient**

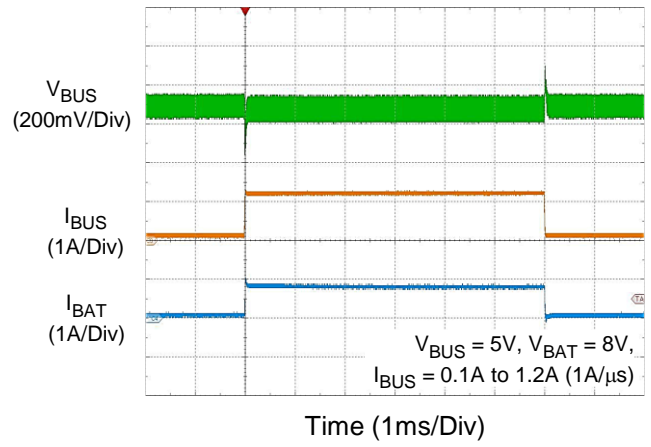

**Seamless**

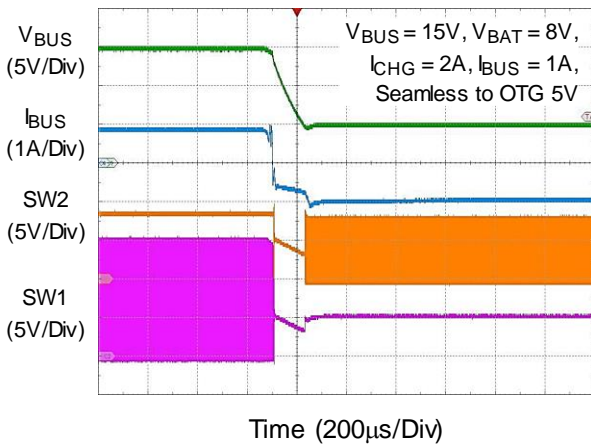

**AICC Enabled**

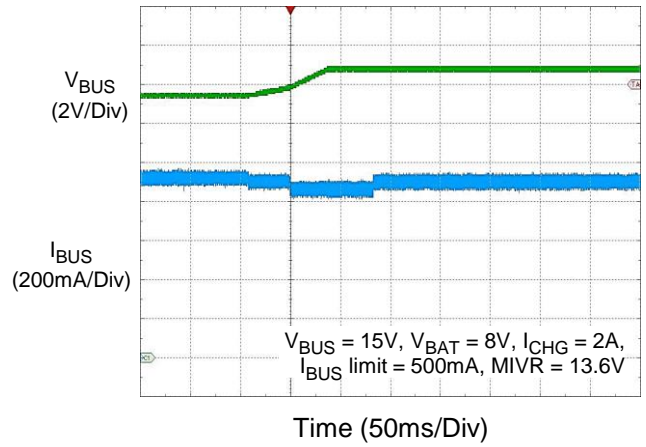

## Register Description

I<sup>2</sup>C Slave Address: 1010011 (53H)

R: Read only

R/W: Read and write

RWS: Read and write, also automatically set by particular condition

RWC: Read and write, also automatically cleared by particular condition

RWSC: Read and write, also automatically set/cleared by particular condition

Register Address: 0x00, Register Name: SYS\_MIN REGU

Bit	Bit Name	Default	WDT RST	REG RST	Type	Description
7:6	RESERVED	00	N	N	R	Reserved
5:0	VSYSMIN	NA	N	Y	RWSC	During POR, the device reads the resistance on PROG pin, to identify the default battery cell count and determine the default VSYSMIN, change REG0x0A[7:6] also change default value 000000: 2.5V 000001: 2.75V ... 000100: 3.5V ... 010010: 7V (2s) ... 011010: 9V (3s) ... 100110: 12V (4s) ... 110101: 15.75V 110110~111111: 16V

Register Address: 0x01, Register Name: VCHG\_CTRL

Bit	Bit Name	Default	WDT RST	REG RST	Type	Description
15:11	RESERVED	00000	N	N	R	Reserved
10:0	VBAT_REG	NA	N	Y	RWSC	During POR, the device reads the resistance on PROG pin, to identify the default battery cell count and determine the default power-on battery voltage, change REG0x0A[7:6] also change default value 00111110100: 5V ... 01101001000: 8.4V (2s) ... 10011101100: 12.6V (3s) ... 11010010000: 16.8V (4s) ... 11101010111: 18.79V 11101011000~11111111111: 18.8V

Register Address: 0x03, Register Name: ICHG\_CTRL

Bit	Bit Name	Default	WDT RST	REG RST	Type	Description
15:9	RESERVED	0000000	N	N	R	Reserved
8:0	ICHG_CTRL	NA	Y	Y	RWSC	During POR, the device reads the resistance on PROG pin, to identify the default battery cell count and determine the default power-on battery charging current, change REG0x0A[7:6] also change default value 0000000000~0000001110: Reserved 000001111: 0.15A 000010000: 0.16A ... 001100100: 1A (3s, 4s) ... 011001000: 2A (2s) ... 111110011: 4.99A 111110100~111111111: 5A

Register Address: 0x05, Register Name: MIVR\_CTRL

Bit	Bit Name	Default	WDT RST	REG RST	Type	Description
7:0	VMIVR	0010 0100	N	N	RWS	MIVR is set to the value based on the VBUS measurement when the adapter plugs in and AUTO_MIVR = 1 00000000~00100100: 3.6V (Default) 00100101: 3.7V ... 01101010: 10.6V ... 11011011: 21.9V 11011100~11111111: 22V

Register Address: 0x06, Register Name: AICR\_CTRL

Bit	Bit Name	Default	WDT RST	REG RST	Type	Description
15:9	RESERVED	00000000	N	N	R	Reserved
8:0	IAICR	10010 1100	N	Y	RWSC	Based on D+/D- detection results, if AUTO_AICR = 1 000000000~000001010: 100mA 000001011: 110mA ... 000110010: 500mA ... 100101100: 3000mA (Default) ... 101001010~111111111: 3300mA

Register Address: 0x08, Register Name: PRE\_CHG

Bit	Bit Name	Default	WDT RST	REG RST	Type	Description
7:6	VPRE_CHG	11	N	Y	R/W	Pre-charge voltage threshold from 00: 15% x VBAT_REG 01: 62% x VBAT_REG 10: 66.5% x VBAT_REG 11: 71.5% x VBAT_REG (Default)
5:0	IPRE_CHG	000011	Y	Y	R/W	Pre-charge current 000000~000010: Reserved 000011: 0.12A (Default) 000100: 0.16A ... 110001: 1.96A 110010~111111: 2A



Register Address: 0x09, Register Name: EOC\_CTRL

Bit	Bit Name	Default	WDT RST	REG RST	Type	Description
7	RST_ALL	0	N	Y	RWC	All registers and logic reset bit. 0: No action (Default) 1: Reset all registers and logic. back to 0 after register and logic reset
6	REG_RST	0	N	Y	RWC	Reset registers to default values and reset timer 0: No action (Default) 1: Reset register and safety timer Back to 0 after register reset
5	Reserved	0	N	N	R	Reserved
4:0	IEOC	00101	Y	Y	R/W	End-of-charge current 00000~00010: Reserved 00011: 0.12A 00100: 0.16A 00101: 0.2A (Default) ... 11000: 0.96A 11001~11111: 1A

Register Address: 0x0A, Register Name: RECHG

Bit	Bit Name	Default	WDT RST	REG RST	Type	Description
7:6	BATTERY_CELL	NA	N	N	R/W	After POR, the device reads the PROG pin resistance to determine the battery cell. 01: 2s 10: 3s 11: 4s This Bit is only for 01, 10,11 setting.
5:4	TRECHG	10	Y	Y	R/W	Re-charge deglitch time 00: 64ms 01: 256ms 10: 1024ms (Default) 11: 2048ms
3:0	VRECHG	0011	Y	Y	R/W	Re-charge voltage threshold 0000: 50mV 0001: 100mV 0010: 150mV 0011: 200mV (Default) ... 1110: 750mV 1111: 800mV

Register Address: 0x0B, Register Name: VOTG\_REGU

Bit	Bit Name	Default	WDT RST	REG RST	Type	Description
15:11	RESERVED	00000	N	N	R	Reserved
10:0	VOTG	000110 11100	Y	Y	R/W	OTG voltage regulation 00000000000: 2.8V 00000000001: 2.81V ... 00011011100: 5V (Default) ... 11101111111: 21.99V 11110000000~11111111111: 22V

Register Address: 0x0D, Register Name: IOTG\_REGU

Bit	Bit Name	Default	WDT RST	REG RST	Type	Description
7	PRECHG_TMR	0	Y	Y	R/W	Pre-charge safe timer 0: 2hrs (Default) 1: 0.5hrs
6:0	IOTG	1001011	Y	Y	R/W	OTG current limit 0000000~0000011: 0.12A 0000100: 0.16A ... 1001011: 3A (Default) ... 1010010: 3.28A 1010011~1111111: 3.32A

Register Address: 0x0E, Register Name: SAFETY\_TMR\_CTRL

Bit	Bit Name	Default	WDT RST	REG RST	Type	Description
7:6	BG_CHG_TMR	00	Y	Y	R/W	EOC back-ground charge timer 00: Disabled (Default) 01: 15mins 10: 30mins 11: 45mins
5	EN_TRICHG_TMR	1	Y	Y	R/W	Trickle charge safe timer enable 0: Disabled 1: Enabled (Default)
4	EN_PRECHG_TMR	1	Y	Y	R/W	Pre-charge safe timer enable 0: Disabled 1: Enabled (Default)
3	EN_FASTCHG_TMR	1	Y	Y	R/W	Fast-charge safe timer enable 0: Disabled 1: Enabled (Default)
2:1	FASTCHG_TMR	10	Y	Y	R/W	Fast-charge safe timer 00: 5hrs 01: 8hrs 10: 12hrs (Default) 11: 24hrs
0	TMR2X_EN	1	Y	Y	R/W	Double charge safe timer during MIVR, AICR, thermal regulation, and JEITA reduce ICHG 0: Disable 2x extended charge safe timer 1: Enable 2x extended charge safe timer (Default)

Register Address: 0x0F, Register Name: CHG\_CTRL 0

Bit	Bit Name	Default	WDT RST	REG RST	Type	Description
7	EN_AUTO_IBATDIS	1	N	Y	R/W	Enable the battery discharging during the battery OVP fault 0: No action when VBAT during VBAT_OVP 1: Apply a discharging resistance on VBAT during VBAT_OVP (Default)
6	FORCE_IBATDIS	0	N	Y	R/W	Force a battery discharging resistance 0: No action (Default) 1: Force a discharging resistance on BAT
5	EN_CHG	1	Y	Y	R/W	Charger enable 0: Disable charge 1: Enable charge (Default)
4	EN_AICC	0	N	Y	R/W	0: Disable AICC function (Default) 1: Enable AICC function
3	FORCE_AICC	0	Y	Y	RWSC	0: No action (Default) 1: Force AICC function Back to 0 after AICC done
2	EN_HZ	0	N	Y	RWSC	Enable HZ mode 0: Disable (Default) 1: Enable Back to 0 when VAC/VBUS present
1	EN_TE	1	Y	Y	R/W	Charge current termination 0: Disable 1: Enable (Default)
0	RESERVED	0	N	N	R	Reserved

Register Address: 0x10, Register Name: CHG\_CTRL 1

Bit	Bit Name	Default	WDT RST	REG RST	Type	Description
7:6	RESERVED	00	N	N	R	Reserved
5:4	VAC_OVP	11	N	Y	R/W	VAC1/VAC2_OVP thresholds 00: 26V 01: 22V 10: 12V 11: 7V (Default)
3	WD_RST	0	Y	Y	RWSC	Watch dog timer reset 0: No action (Default) 1: Reset Back to 0 after WDT resets
2:0	WATCHDOG	101	N	Y	R/W	Watchdog timer settings 000: Disable 001: 0.5s 010: 1s 011: 2s 100: 20s 101: 40s (Default) 110: 80s 111: 160s

Register Address: 0x11, Register Name: CHG\_CTRL 2

Bit	Bit Name	Default	WDT RST	REG RST	Type	Description
7	FORCE_DPDM_DET_EN	0	Y	Y	RWSC	Force D+/D- detection 0: No action (Default) 1: Force D+/D- detection Back to 0 while D+/D- detect done
6	BC12_EN	1	Y	Y	R/W	0: Disable BC1.2 detection 1: Enable BC1.2 detection (Default)
5:4	RESERVED	00	N	N	R	Reserved
3	DIS_EOC_FCCM	1	N	Y	R/W	Enable FCCM for EOC during TD_EOC 0: Enable EOC FCCM 1: Disable EOC FCCM (Default)
2:1	SDRV_CTRL	00	N	Y	RWSC	SHIP FET gate driver control mode 00: IDLE (Default) 01: Shutdown Mode 10: Ship Mode 11: System Power Reset Back to 00 when SHIP_FET_PRESENT=0 or exit Shutdown Mode or exit Ship Mode or finish System Power Reset. Set to Ship mode when SHIP_FET_PRESENT = 1 and trigger IBAT_OCP or VSYS_SHORT
0	SDRV_DLY	0	N	Y	R/W	SHIP FET turn off delay time when SDRV_CTRL not equal to 00 0: Add 10s delay time (Default) 1: Do NOT add 10s delay time

Register Address: 0x12, Register Name: CHG\_CTRL 3

Bit	Bit Name	Default	WDT RST	REG RST	Type	Description
7	DIS_ACDRV_EN	0	N	N	RWSC	Force both EN_ACDRV1 = 0 and EN_ACDRV2 = 0 0: Not Force (Default) 1: Force EN_ACDRV1 = 0 and EN_ACDRV2 = 0 Clear to 0 when VAC1/VAC2 not present and EN_OTG disable
6	EN_OTG	0	Y	Y	RWSC	OTG mode control 0: Disable OTG (Default) 1: Enable OTG (Back to 0 when OTG_UVP, OTG_LBP. Set to 1 when SEAMLESS operating)
5:4	RESERVED	00	N	N	R	Reserved
3	QON_EXIT_SHIP_DLY	0	N	Y	R/W	QON pin pull low time to exit ship mode 0: 1s (Default) 1: 15ms
2	DIS_LDO	0	Y	Y	RWC	Disable BATFET LDO mode in SYSMIN 0: Enable BATFET regulation for SYSMIN(Default) 1: Disable BATFET regulation (Clear to 0 when power path turn off or VBUS no input)
1	DIS_OTG_OOA	0	Y	Y	R/W	Disable OOA in OTG mode 0: Enable OOA function in OTG mode(Default) 1: Disable OOA function in OTG mode
0	DIS_CHG_OOA	0	N	Y	R/W	Disable OOA in charge mode 0: Enable OOA function in charge mode(Default) 1: Disable OOA function in charge mode

Register Address: 0x13, Register Name: CHG\_CTRL 4

Bit	Bit Name	Default	WDT RST	REG RST	Type	Description
7	EN_ACDRV2	0	N	N	RWSC	External ACFET2 gate driver 0: Turn off (Default) 1: Turn on (Set to 1 when VAC2 present, back to 0 after VAC2 not present or lock at 0 if there is no external ACFET2)
6	EN_ACDRV1	0	N	N	RWSC	External ACFET1 gate driver 0: Turn off (Default) 1: Turn on (Set to 1 when VAC1 present, back to 0 after VAC1 not present or lock at 0 if there is no external ACFET1)
5	PWM_FREQ	NA	N	N	RWSC	Switching frequency selection, after POR, default value is based on PROG pin 0: 1.5MHz 1: 750kHz
4	DIS_STAT	0	Y	Y	R/W	STAT pin output 0: Enable STAT pin output (Default) 1: Disable STAT pin output
3	DIS_VSYS_UVP_HICCUP	0	N	Y	R/W	VSYS_UVP hiccup protection. 0: Enable VSYS_UVP hiccup protection (Default) 1: Disable VSYS_UVP hiccup, converter continue switching
2	DIS_VOTG_UVP_HICCUP	0	N	Y	R/W	OTG mode VOTG UVP hiccup protection. 0: Enable VOTG_UVP hiccup protection (Default) 1: Disable VOTG_UVP hiccup, converter continue switching
1	FORCE_MIVR_DET	0	N	Y	RWC	Force MIVR detection 0: No action (Default) 1: Force the converter stop switching, and ADC VBUS for MIVR detection (Back to 0 after force MIVR detection done)
0	EN_IBUS_OCP	1	N	Y	R/W	Enable IBUS_OCP 0: Disable 1: Enable (Default)

Register Address: 0x14, Register Name: CHG\_CTRL 5

Bit	Bit Name	Default	WDT RST	REG RST	Type	Description
7	SHIP_FET_PRESENT	0	N	N	R/W	The user has to set this bit based on whether a SHIP FET is used or not. 0: No external SHIP FET (Default) 1: Use external SHIP FET
6	RESERVED	0	N	N	R	Reserved
5	IBAT_PIN_EN	0	Y	Y	R/W	IBAT pin output enable 0: IBAT pin output is disabled (Default) 1: IBAT pin output is enable
4:3	IBAT_REG	10	Y	Y	RWC	Battery discharging current regulation during OTG 00: 3A 01: 4A 10: 5A (Default) 11: Disable
2	EN_AICR	1	Y	Y	RWC	AICR loop control 0: Disable 1: Enable (Default)
1	ILIM_HZ_EN	1	N	Y	R/W	ILIM_HZ pin current limit setting 0: Disable 1: Enable (Default)
0	EN_IBAT_OCP	0	Y	Y	RWSC	Enable the battery discharging current OCP 0: Disable (Default) 1: Enable (Back to 0 when SHIP_FET_PRESENT = 0)



Register Address: 0x16, Register Name: THREG\_CTRL

Bit	Bit Name	Default	WDT RST	REG RST	Type	Description
7:6	THREG	11	Y	Y	R/W	Thermal regulation threshold 00: 60°C 01: 80°C 10: 100°C 11: 120°C (Default)
5:4	TOTP	00	Y	Y	R/W	Over thermal protection thresholds. 00: 150°C (Default) 01: 130°C 10: 120°C 11: 85°C
3	VBUS_PD_EN	0	N	Y	R/W	VBUS pull-down resistor 0: Disable (Default) 1: Enable
2	VAC1_PD_EN	0	N	Y	R/W	VAC1 pull-down resistor 0: Disable (Default) 1: Enable
1	VAC2_PD_EN	0	N	Y	R/W	VAC2 pull-down resistor 0: Disable (Default) 1: Enable
0	THREG_HYS	0	N	Y	R/W	Thermal Regulation Falling Hysteresis 0: 10°C (Default) 1: 20°C

Register Address: 0x17, Register Name: JEITA\_CTRL 0

Bit	Bit Name	Default	WDT RST	REG RST	Type	Description
7:5	JEITA_VSET_WARM	011	Y	Y	R/W	JEITA WARM charge voltage setting 000: Stop charging 001: Set VBAT_REG to VBAT_REG-800mV 010: Set VBAT_REG to VBAT_REG-600mV 011: Set VBAT_REG to VBAT_REG-400mV (Default) 100: Set VBAT_REG to VBAT_REG-300mV 101: Set VBAT_REG to VBAT_REG-200mV 110: Set VBAT_REG to VBAT_REG-100mV 111: VBAT_REG = Register setting
4:3	JEITA_ISET_WARM	11	Y	Y	R/W	JEITA WARM charge current setting 00: Stop charging 01: Set ICHG to 25% x ICHG 10: Set ICHG to 50% x ICHG 11: ICHG = Register setting (Default)
2:1	JEITA_ISET_COOL	01	Y	Y	R/W	JEITA COOL charge current setting 00: Stop charging 01: Set ICHG to 25% x ICHG (Default) 10: Set ICHG to 50% x ICHG 11: ICHG = Register setting
0	RESERVED	0	N	N	R	Reserved

Register Address: 0x18, Register Name: JEITA\_CTRL 1

Bit	Bit Name	Default	WDT RST	REG RST	Type	Description
7:6	TS_COOL	01	Y	Y	R/W	TS COOL temperature threshold 00: 71.1% (5°C) 01: 68.4% (10°C) (Default) 10: 65.5% (15°C) 11: 62.4% (20°C)
5:4	TS_WARM	01	Y	Y	R/W	TS WARM temperature threshold 00: 48.4% (40°C) 01: 44.8% (45°C) (Default) 10: 41.2% (50°C) 11: 37.7% (55°C)
3:2	OTG_HOT	01	Y	Y	R/W	OTG mode TS HOT temperature threshold 00: 37.7% (55°C) 01: 34.4% (60°C) (Default) 10: 31.3% (65°C) 11: Disable
1	OTG_COLD	0	Y	Y	R/W	OTG mode TS COLD temperature threshold 0: 77.1% (-10°C) (Default) 1: 80% (-20°C)
0	JEITA_DIS	0	Y	Y	R/W	Disable JEITA function 0: NOT disable (Default) 1: Disable

Register Address: 0x19, Register Name: AICC\_CTRL

Bit	Bit Name	Default	WDT RST	REG RST	Type	Description
15:9	RESERVED	0000000	N	N	R	Reserved
8:0	IAICC	00000 0000	N	N	R	AICR current limit by Average Input Current Control or ILIM_HZ pin 000000000: 0mA (Default) 000001010: 100mA 000001011: 110mA ... 000110010: 500mA ... 100101100: 3000mA ... 101001010: 3300mA

Register Address: 0x1B, Register Name: CHG\_STATUS 0

Bit	Bit Name	Default	WDT RST	REG RST	Type	Description
7	AICR_STAT	0	N	N	R	AICR status (charge mode) or OTG_CC status (OTG mode) 0: Normal (Default) 1: In AICR/OTG_CC
6	MIVR_STAT	0	N	N	R	MIVR status (charge mode) or OTG_CV status (OTG mode) 0: Normal (Default) 1: In MIVR/OTG_CV
5	WDT_STAT	0	N	N	R	Watch dog timer status 0: Normal (Default) 1: Watchdog timeout
4	RESERVED	0	N	N	R	Reserved
3	VBUS_GD_RDY_STAT	0	N	N	R	VBUS good ready for charge status 0: VBUS NOT good ready for charge status (Default) 1: VBUS good ready for charge status (Notice: After bad adapter detection, REG_HZ = 0, VBUS_OVP = 0)
2	VAC2_PG_STAT	0	N	N	R	VAC2 power good status 0: VAC2 NOT power good (Default) 1: VAC2 power good (Notice: Above VAC_UVLO threshold, VAC2_OVP = 0)
1	VAC1_PG_STAT	0	N	N	R	VAC1 power good status 0: VAC1 NOT power good (Default) 1: VAC1 power good (Notice: Above VAC_UVLO threshold, VAC1_OVP = 0)
0	VBUS_PG_STAT	0	N	N	R	VBUS power good status 0: VBUS NOT power good (Default) 1: VBUS power good (Notice: Above VBUS_UVLO threshold, HZ = 0, VBUS_OVP = 0)

Register Address: 0x1C, Register Name: CHG\_STATUS 1

Bit	Bit Name	Default	WDT RST	REG RST	Type	Description
7:5	CHG_STAT	000	N	N	R	Charge status bits 000: Not charging (Default) 001: Trickle Charge 010: Pre-charge 011: Fast charge (CC mode) 100: Fast charge (CV mode) 101: IEOC (EOC and TE = 0) 110: Back-Ground Charging (EOC and TE = 1 and before BATFET turn off) 111: Charge Done (EOC and TE = 1 and BATFET turn off)
4:1	VBUS_STAT	0000	N	N	R	VBUS status bits 0000: No input or Input NOT from BC12_EN_CHANNEL (Default) 0001: USB SDP (0.5A) 0010: USB CDP (1.5A) 0011: USB DCP (3.25A) 0100: Adjustable DCP 0101: NSDP/Unknown (3.25A) 0110: Special Adapter (1A/2A/2.1A/2.4A) 0111: In OTG mode 1000: Not verify adapter/Bad adapter 1001: Reserved 1010: Reserved 1011: Device directly powered from VBUS 1100: Reserved 1101: Reserved 1110: Reserved 1111: Reserved
0	BC12_DONE_STAT	0	N	N	R	BC1.2 status bit 0: BC1.2 NOT complete (Default) 1: BC1.2 done

Register Address: 0x1D, Register Name: CHG\_STATUS 2

Bit	Bit Name	Default	WDT RST	REG RST	Type	Description
7:6	AICC_STAT	00	N	N	R	Average Input Current Control status 00: AICC disabled (Default) 01: AICC optimization in progress 10: Maximum input current detected 11: Reserved
5	CDP_PD_STAT	0	N	N	R	CDP primary detection start 0: CDP primary detection does not start (Default) 1: CDP primary detection started (Notice: This bit will be updated when HOST mode is changed.)
4	CDP_DONE_STAT	0	N	N	R	CDP flow done 0: No CDP flow (Default) 1: CDP flow done (Notice: this bit will be updated when HOST mode is changed.)
3	RESERVED	0	N	N	R	Reserved
2	THREG_STAT	0	N	N	R	Thermal regulation status 0: Normal (Default) 1: In thermal regulation
1	DPDM_STAT	0	N	N	R	D+/D- detection status bits 0: The D+/D- detection is NOT started yet, or the detection is done (Default) 1: The D+/D- detection is ongoing
0	VBAT_PG_STAT	0	N	N	R	VBAT power good status 0: VBAT NOT power good (Default) 1: VBAT power good (Notice: VBAT > VBAT_UVLO)

Register Address: 0x1E, Register Name: CHG\_STATUS 3

Bit	Bit Name	Default	WDT RST	REG RST	Type	Description
7	ACRB2_STAT	0	N	N	R	The ACFET2-RBFET2 status 0: ACFET2-RBFET2 is NOT placed (Default) 1: ACFET2-RBFET2 is placed
6	ACRB1_STAT	0	N	N	R	The ACFET1-RBFET1 status 0: ACFET1-RBFET1 is NOT placed (Default) 1: ACFET1-RBFET1 is placed
5	ADC_DONE_STAT	0	N	N	R	ADC Status (in one-shot mode only) 0: ADC NOT complete (Default) 1: ADC done
4	VSYSMIN_STAT	0	N	N	R	VSYS_MIN Regulation Status 0: Not in SYS_MIN regulation (VBAT > VSYS_MIN) (Default) 1: In SYS_MIN regulation (VBAT < VSYS_MIN)
3	FASTCHG_TMR_STAT	0	N	N	R	Fast charge safety timer status 0: Normal (Default) 1: Fast charge safety timer timeout
2	TRICHG_TMR_STAT	0	N	N	R	Trickle charge safety timer status 0: Normal (Default) 1: Trickle charge safety timer timeout
1	PRECHG_TMR_STAT	0	N	N	R	Pre-charge safety timer status 0: Normal (Default) 1: Pre-charge safety timer timeout
0	RESERVED	0	N	N	R	Reserved

Register Address: 0x1F, Register Name: CHG\_STATUS 4

Bit	Bit Name	Default	WDT RST	REG RST	Type	Description
7:4	RESERVED	0000	N	N	R	Reserved
3	JEITA_COLD_STAT	0	N	N	R	The TS temperature is in the cold range 0: NOT in cold range (Default) 1: In cold range
2	JEITA_COOL_STAT	0	N	N	R	The TS temperature is in the cool range 0: NOT in cool range (Default) 1: In cool range
1	JEITA_WARM_STAT	0	N	N	R	The TS temperature is in the warm range 0: NOT in warm range (Default) 1: In warm range
0	JEITA_HOT_STAT	0	N	N	R	The TS temperature is in the hot range 0: NOT in hot range (Default) 1: In hot range

Register Address: 0x20, Register Name: FAULT\_STATUS 0

Bit	Bit Name	Default	WDT RST	REG RST	Type	Description
7	IBAT_REG_STAT	0	N	N	R	IBAT regulation when in OTG mode 0: Not in battery current regulation (Default) 1: In battery current regulation
6	VBUS_OVP_STAT	0	N	N	R	VBUS overvoltage protection status 0: Not in VBUS OVP (Default) 1: In VBUS OVP
5	VBAT_OVP_STAT	0	N	N	R	VBAT overvoltage protection status 0: Not in VBAT OVP (Default) 1: In VBAT OVP
4:3	RESERVED	00	N	N	R	Reserved
2	CYC_OCP_STAT	0	N	N	R	Converter cycle-by-cycle overcurrent protection status 0: Not in Cycle-by-Cycle OCP (Default) 1: In Cycle-by-Cycle OCP
1	VAC2_OVP_STAT	0	N	N	R	VAC2 overvoltage protection status 0: Not in VAC2 OVP (Default) 1: In VAC2 OVP
0	VAC1_OVP_STAT	0	N	N	R	VAC1 overvoltage protection status 0: Not in VAC1 OVP (Default) 1: In VAC1 OVP

Register Address: 0x21, Register Name: FAULT\_STATUS 1

Bit	Bit Name	Default	WDT RST	REG RST	Type	Description
7	VSYS_UVP_STAT	0	N	N	R	VSYS undervoltage protection status 0: Not in VSYS UVP (Default) 1: In VSYS UVP
6	VSYS_OVP_STAT	0	N	N	R	VSYS overvoltage protection status 0: Not in VSYS OVP (Default) 1: In VSYS OVP
5	OTG_OVP_STAT	0	N	N	R	OTG overvoltage protection status 0: Not in OTG OVP (Default) 1: In OTG OVP
4:3	RESERVED	00	N	N	R	Reserved
2	TOTP_STAT	0	N	N	R	IC over-temperature shutdown status 0: Not in OTP (Default) 1: In OTP
1	RESERVED	00	N	N	R	Reserved

Register Address: 0x22, Register Name: CHG\_IRQ\_FLAG 0

Bit	Bit Name	Default	WDT RST	REG RST	Type	Description
7	AICR_FLAG	0	N	N	R	AICR flag or OTG_CC flag 0: Normal (Default) 1: Any change in AICR_STAT/OTG_CC_STAT, read clear
6	MIVR_FLAG	0	N	N	R	MIVR flag or OTG_CV flag 0: Normal (Default) 1: Any change in MIVR_STAT/OTG_CV_STAT, read clear
5	WDT_FLAG	0	N	N	R	I <sup>2</sup> C watchdog timer flag 0: Normal (Default) 1: WDT_STAT rising, read clear
4	BAD_ADAPTER_FLAG	0	N	N	R	Bad adapter detection flag 0: Normal (Default) 1: While I <sub>BUS</sub> < Bad adapter detection sink source, read clear
3	VBUS_GD_RDY_FLAG	0	N	N	R	VBUS good ready for charge flag 0: Normal (Default) 1: Any change in VBUS_GD_RDY_STAT even, read clear
2	VAC2_PG_FLAG	0	N	N	R	VAC2 power good flag 0: Normal (Default) 1: Any change in VAC2_PG_STAT, read clear
1	VAC1_PG_FLAG	0	N	N	R	VAC1 power good flag 0: Normal (Default) 1: Any change in VAC1_PG_STAT, read clear
0	VBUS_PG_FLAG	0	N	N	R	VBUS power good flag 0: Normal (Default) 1: Any change in VBUS_PG_STAT, read clear



Register Address: 0x23 Register Name: CHG\_IRQ\_FLAG 1

Bit	Bit Name	Default	WDT RST	REG RST	Type	Description
7	CHG_FLAG	0	N	N	R	Charge status flag 0: Normal (Default) 1: Any change in CHG_STAT, read clear
6	AICC_FLAG	0	N	N	R	AICC status flag 0: Normal (Default) 1: Any change in AICC_STAT, read clear
5	RESERVED	0	N	N	R	Reserved
4	VBUS_FLAG	0	N	N	R	VBUS status flag 0: Normal (Default) 1: Any change in VBUS_STAT, read clear
3	RESERVED	0	N	N	R	Reserved
2	THREG_FLAG	0	N	N	R	IC thermal regulation flag 0: Normal (Default) 1: THREG_STAT rising, read clear
1	VBAT_PG_FLAG	0	N	N	R	VBAT power good flag 0: Normal (Default) 1: Any change in VBAT_PG_STAT, read clear
0	BC12_DONE_FLAG	0	N	N	R	BC1.2 done Flag 0: BC1.2 detection not ready (Default) 1: BC12_DONE_STAT rising detection done, read clear

Register Address: 0x24 Register Name: CHG\_IRQ\_FLAG 2

Bit	Bit Name	Default	WDT RST	REG RST	Type	Description
7	RESERVED	0	N	N	R	Reserved
6	DPDM_DONE_FLAG	0	N	N	R	D+/D- detection is done flag. 0: D+/D- detection is NOT started or still ongoing (Default) 1: D+/D- detection is completed, read clear
5	ADC_DONE_FLAG	0	N	N	R	ADC done flag (only in one-shot mode) 0: ADC NOT completed (Default) 1: ADC done, read clear
4	VSYSMIN_FLAG	0	N	N	R	VSYSMIN regulation flag 0: Normal (Default) 1: Any change in VSYSMIN_STAT, read clear
3	FASTCHG_TMR_FLAG	0	N	N	R	Fast charge timer timeout flag 0: Normal (Default) 1: FASTCHG_TMR_STAT rising, read clear
2	TRICHG_TMR_FLAG	0	N	N	R	Trickle charge timer timeout flag 0: Normal (Default) 1: TRICHG_TMR_STAT rising, read clear
1	PRECHG_TMR_FLAG	0	N	N	R	Pre-charge timer timeout flag 0: Normal (Default) 1: PRECHG_TMR_STAT rising, read clear
0	BG_TMR_FLAG	0	N	N	R	Back-ground charge timer flag 0: Normal (Default) 1: Back-ground charge timer timeout rising, read clear

Register Address: 0x25 Register Name: CHG\_IRQ\_FLAG 3

Bit	Bit Name	Default	WDT RST	REG RST	Type	Description
7:5	RESERVED	000	N	N	R	Reserved
4	OTG_LBP_FLAG	0	N	N	R	The VBAT is under OTG_LBP 0: Normal (Default) 1: OTG_LBP_STAT rising, read clear
3	JEITA_COLD_FLAG	0	N	N	R	JEITA_COLD flag 0: Normal (Default) 1: JEITA_COLD_STAT rising, read clear
2	JEITA_COOL_FLAG	0	N	N	R	JEITA_COOL flag 0: Normal (Default) 1: JEITA_COOL_STAT rising, read clear
1	JEITA_WARM_FLAG	0	N	N	R	JEITA_COOL flag 0: Normal (Default) 1: JEITA_WARM_STAT rising, read clear
0	JEITA_HOT_FLAG	0	N	N	R	JEITA_HOT flag 0: Normal (Default) 1: JEITA_HOT_STAT rising, read clear

Register Address: 0x26 Register Name: CHG\_IRQ\_FLAG 4

Bit	Bit Name	Default	WDT RST	REG RST	Type	Description
7	IBAT_REG_FLAG	0	N	N	R	When in OTG, IBAT regulation flag 0: Normal (Default) 1: Any change in IBAT_STAT, read clear
6	VBUS_OVP_FLAG	0	N	N	R	VBUS overvoltage protection flag 0: Normal (Default) 1: VBUS_OVP_STAT rising, read clear
5	VBAT_OVP_FLAG	0	N	N	R	VBAT overvoltage protection flag 0: Normal (Default) 1: VBAT_OVP_STAT rising, read clear
4	IBUS_OCP_FLAG	0	N	N	R	IBUS overcurrent protection flag 0: Normal (Default) 1: IBUS_OCP_STAT rising, read clear
3	IBAT_OCP_FLAG	0	N	N	R	IBAT overcurrent protection flag 0: Normal (Default) 1: IBAT_OCP_STAT rising, read clear
2	CYC_OCP_FLAG	0	N	N	R	Cycle-by-cycle overcurrent protection flag 0: Normal (Default) 1: CYC_OCP_FLAG rising, read clear
1	VAC2_OVP_FLAG	0	N	N	R	VAC2 overvoltage protection flag 0: Normal (Default) 1: VAC2_OVP_STAT rising, read clear
0	VAC1_OVP_FLAG	0	N	N	R	VAC1 overvoltage protection flag 0: Normal (Default) 1: VAC1_OVP_STAT rising, read clear

Register Address: 0x27 Register Name: CHG\_IRQ\_FLAG 5

Bit	Bit Name	Default	WDT RST	REG RST	Type	Description
7	VSYS_UVP_FLAG	0	N	N	R	VSYS undervoltage protection flag 0: Normal (Default) 1: VSYS_UVP_STAT rising, read clear
6	VSYS_OVP_FLAG	0	N	N	R	VSYS overvoltage flag 0: Normal (Default) 1: VSYS_OVP_STAT rising, read clear
5	OTG_OVP_FLAG	0	N	N	R	OTG overvoltage flag 0: Normal (Default) 1: OTG_OVP_STAT rising, read clear
4	OTG_UVP_FLAG	0	N	N	R	OTG undervoltage flag 0: Normal (Default) 1: OTG_UVP_STAT rising, read clear
3	RESERVED	0	N	N	R	Reserved
2	TOTP_FLAG	0	N	N	R	IC thermal shutdown flag 0: Normal (Default) 1: TOTP_STAT rising, read clear
1:0	RESERVED	00	N	N	R	Reserved

Register Address: 0x28 Register Name: CHG\_IRQ\_MASK 0

Bit	Bit Name	Default	WDT RST	REG RST	Type	Description
7	AICR_MASK	0	N	Y	R/W	0: Not mask IRQ of AICR_FLAG (Default) 1: Mask IRQ of AICR_FLAG
6	MIVR_MASK	0	N	Y	R/W	0: Not mask IRQ of MIVR_FLAG (Default) 1: Mask IRQ of MIVR_FLAG
5	WDT_MASK	0	N	Y	R/W	0: Not mask IRQ of WDT_FLAG (Default) 1: Mask IRQ of WDT_FLAG
4	BAD_ADAPTER_MASK	0	N	Y	R/W	0: Not mask IRQ of BAD_ADAPTER_FLAG (Default) 1: Mask IRQ of BAD_ADAPTER_FLAG
3	VBUS_GD_RDY_MASK	0	N	Y	R/W	0: Not mask IRQ of VBUS_GD_RDY_FLAG (Default) 1: Mask IRQ of VBUS_GD_RDY_FLAG
2	VAC2_PG_MASK	0	N	Y	R/W	0: Not mask IRQ of VAC2_PG_FLAG (Default) 1: Mask IRQ of VAC2_PG_FLAG
1	VAC1_PG_MASK	0	N	Y	R/W	0: Not mask IRQ of VAC1_PG_FLAG (Default) 1: Mask IRQ of VAC1_PG_FLAG
0	VBUS_PG_MASK	0	N	Y	R/W	0: Not mask IRQ of VBUS_PG_FLAG (Default) 1: Mask IRQ of VBUS_PG_FLAG

Register Address: 0x29 Register Name: CHG\_IRQ\_MASK 1

Bit	Bit Name	Default	WDT RST	REG RST	Type	Description
7	CHG_MASK	0	N	Y	R/W	0: Not mask IRQ of CHG_FLAG (Default) 1: Mask IRQ of CHG_FLAG
6	AICC_MASK	0	N	Y	R/W	0: Not mask IRQ of AICC_FLAG (Default) 1: Mask IRQ of AICC_FLAG
5	RESERVED	0	N	N	R	Reserved
4	VBUS_MASK	0	N	Y	R/W	0: Not mask IRQ of VBUS_FLAG (Default) 1: Mask IRQ of VBUS_FLAG
3	RESERVED	0	N	N	R	Reserved
2	THREG_MASK	0	N	Y	R/W	0: Not mask IRQ of THREG_FLAG (Default) 1: Mask IRQ of THREG_FLAG
1	VBAT_PG_MASK	0	N	Y	R/W	0: Not mask IRQ of VBAT_PG_FLAG (Default) 1: Mask IRQ of VBAT_PG_FLAG
0	BC1.2_DONE_MASK	0	N	Y	R/W	0: Not mask IRQ of BC1.2_DONE_FLAG (Default) 1: Mask IRQ of BC1.2_DONE_FLAG

Register Address: 0x2A Register Name: CHG\_IRQ\_MASK 2

Bit	Bit Name	Default	WDT RST	REG RST	Type	Description
7	RESERVED	0	N	N	R	Reserved
6	DPDM_DONE_MASK	0	N	Y	R/W	0: Not mask IRQ of DPDM_DONE_FLAG (Default) 1: Mask IRQ of DPDM_DONE_FLAG
5	ADC_DONE_MASK	0	N	Y	R/W	0: Not mask IRQ of ADC_DONE (Default) 1: Mask IRQ of ADC_DONEG
4	VSYSMIN_MASK	0	N	Y	R/W	0: Not mask IRQ of VSYSMIN_FLAG (Default) 1: Mask IRQ of VSYSMIN_FLAG
3	FASTCHG_TMR_MASK	0	N	Y	R/W	0: Not mask IRQ of FASTCHG_TMR_FLAG (Default) 1: Mask IRQ of FASTCHG_TMR_FLAG
2	TRICHG_TMR_MASK	0	N	Y	R/W	0: Not mask IRQ of TRICHG_TMR_FLAG (Default) 1: Mask IRQ of TRICHG_TMR_FLAG
1	PRECHG_TMR_MASK	0	N	Y	R/W	0: Not mask IRQ of PRECHG_TMR_FLAG (Default) 1: Mask IRQ of PRECHG_TMR_FLAG
0	BG_TMR_MASK	0	N	Y	R/W	0: Not mask IRQ of BG_TMR_FLAG (Default) 1: Mask IRQ of BG_TMR_FLAG

Register Address: 0x2B Register Name: CHG\_IRQ\_MASK 3

Bit	Bit Name	Default	WDT RST	REG RST	Type	Description
7:5	RESERVED	000	N	N	R	Reserved
4	OTG_LBP_MASK	0	Y	Y	R/W	0: Not mask IRQ of OTG_LBP_FLAG (Default) 1: Mask IRQ of OTG_LBP_FLAG
3	JEITA_COLD_MASK	0	Y	Y	R/W	0: Not mask IRQ of JEITA_COLD_FLAG (Default) 1: Mask IRQ of JEITA_COLD_FLAG
2	JEITA_COOL_MASK	0	Y	Y	R/W	0: Not mask IRQ of JEITA_COOL_FLAG (Default) 1: Mask IRQ of JEITA_COOL_FLAG
1	JEITA_WARM_MASK	0	Y	Y	R/W	0: Not mask IRQ of JEITA_WARM_FLAG (Default) 1: Mask IRQ of JEITA_WARM_FLAG
0	JEITA_HOT_MASK	0	Y	Y	R/W	0: Not mask IRQ of JEITA_HOT_FLAG (Default) 1: Mask IRQ of JEITA_HOT_FLAG

Register Address: 0x2C Register Name: CHG\_IRQ\_MASK 4

Bit	Bit Name	Default	WDT RST	REG RST	Type	Description
7	IBAT_REG_MASK	0	N	Y	R/W	0: Not mask IRQ of IBAT_REG_FLAG (Default) 1: Mask IRQ of IBAT_REG_FLAG
6	VBUS_OVP_MASK	0	N	Y	R/W	0: Not mask IRQ of VBUS_OVP_FLAG (Default) 1: Mask IRQ of VBUS_OVP_FLAG
5	VBAT_OVP_MASK	0	N	Y	R/W	0: Not mask IRQ of VBAT_OVP_FLAG (Default) 1: Mask IRQ of VBAT_OVP_FLAG
4	IBUS_OCP_MASK	0	N	Y	R/W	0: Not mask IRQ of IBUS_OCP_FLAG (Default) 1: Mask IRQ of IBUS_OCP_FLAG
3	IBAT_OCP_MASK	0	N	Y	R/W	0: Not mask IRQ of IBAT_OCP_FLAG (Default) 1: Mask IRQ of IBAT_OCP_FLAG
2	CYC_OCP_MASK	0	N	Y	R/W	0: Not mask IRQ of CYC_OCP_FLAG (Default) 1: Mask IRQ of CYC_OCP_FLAG
1	VAC2_OVP_MASK	0	N	Y	R/W	0: Not mask IRQ of VAC2_OVP_FLAG (Default) 1: Mask IRQ of VAC2_OVP_FLAG
0	VAC1_OVP_MASK	0	N	Y	R/W	0: Not mask IRQ of VAC1_OVP_FLAG (Default) 1: Mask IRQ of VAC1_OVP_FLAG

Register Address: 0x2D Register Name: CHG\_IRQ\_MASK 5

Bit	Bit Name	Default	WDT RST	REG RST	Type	Description
7	VSYS_UVP_MASK	0	N	Y	R/W	0: Not mask IRQ of VSYS_UVP_FLAG (Default) 1: Mask IRQ of VSYS_UVP_FLAG
6	VSYS_OVP_MASK	0	N	Y	R/W	0: Not mask IRQ of VSYS_OVP_FLAG (Default) 1: Mask IRQ of VSYS_OVP_FLAG
5	OTG_OVP_MASK	0	N	Y	R/W	0: Not mask IRQ of OTG_OVP_FLAG (Default) 1: Mask IRQ of OTG_OVP_FLAG
4	OTG_UVP_MASK	0	N	Y	R/W	0: Not mask IRQ of OTG_UVP_FLAG (Default) 1: Mask IRQ of OTG_UVP_FLAG
3	RESERVED	0	N	N	R	Reserved
2	TOTP_MASK	0	N	Y	R/W	0: Not mask IRQ of TOTP_FLAG (Default) 1: Mask IRQ of TOTP_FLAG
1:0	RESERVED	00	N	N	R	Reserved

Register Address: 0x2E Register Name: ADC\_CTRL

Bit	Bit Name	Default	WDT RST	REG RST	Type	Description
7	ADC_EN	0	Y	Y	R/W	ADC control 0: Disable (Default) 1: Enable (Back to 0, when one shot conversion finish.)
6	ADC_CONV_CTRL	0	N	Y	R/W	ADC conversion control 0: Continuous conversion (Default) 1: One shot conversion
5:0	RESERVED	000000	N	N	R	Reserved

Register Address: 0x2F Register Name: ADC\_CNANNEL 0

Bit	Bit Name	Default	WDT RST	REG RST	Type	Description
7	IBUS_ADC_DIS	0	N	Y	R/W	IBUS ADC control 0: Enable (Default) 1: Disable
6	IBAT_ADC_DIS	0	N	Y	R/W	IBAT ADC control 0: Enable (Default) 1: Disable
5	VBUS_ADC_DIS	0	N	Y	R/W	VBUS ADC control 0: Enable (Default) 1: Disable
4	VBAT_ADC_DIS	0	N	Y	R/W	VBAT ADC control 0: Enable (Default) 1: Disable
3	VSYS_ADC_DIS	0	N	Y	R/W	VSYS ADC control 0: Enable (Default) 1: Disable
2	TS_ADC_DIS	0	N	Y	R/W	TS ADC control 0: Enable (Default) 1: Disable
1	TDIE_ADC_DIS	0	N	Y	R/W	TDIE ADC control 0: Enable (Default) 1: Disable
0	RESERVED	1	Y	Y	R/W	Reserved

Register Address: 0x30 Register Name: ADC\_CNANNEL 1

Bit	Bit Name	Default	WDT RST	REG RST	Type	Description
7	DP_ADC_DIS	0	N	Y	R/W	D+ ADC control 0: Enable (Default) 1: Disable
6	DM_ADC_DIS	0	N	Y	R/W	D- ADC control 0: Enable (Default) 1: Disable
5	VAC2_ADC_DIS	0	N	Y	R/W	VAC2 ADC control 0: Enable (Default) 1: Disable
4	VAC1_ADC_DIS	0	N	Y	R/W	VAC1 ADC control 0: Enable (Default) 1: Disable
3:0	RESERVED	0000	N	N	R	Reserved

Register Address: 0x31 Register Name: IBUS\_ADC

Bit	Bit Name	Default	WDT RST	REG RST	Type	Description
15:0	IBUS_ADC	0	N	N	R	IBUS ADC reading, LSB: 1mA Reported in 2's complement for discharge value. IBUS ADC reports charge value and discharge value. (Notice: Charge: VBUS to PMID; Discharge: PMID to VBUS)

Register Address: 0x33 Register Name: IBAT\_ADC

Bit	Bit Name	Default	WDT RST	REG RST	Type	Description
15:0	IBAT_ADC	0	N	N	R	IBAT ADC reading, LSB: 1mA Reported in 2's complement for discharge value. IBAT ADC reports charge value and discharge value. (Notice: Charge: VSYS to VBAT; Discharge: VBAT to VSYS)

Register Address: 0x35 Register Name: VBUS\_ADC

Bit	Bit Name	Default	WDT RST	REG RST	Type	Description
15:0	VBUS_ADC	0	N	N	R	VBUS ADC reading, LSB: 1mV



Register Address: 0x37 Register Name: VAC1\_ADC

Bit	Bit Name	Default	WDT RST	REG RST	Type	Description
15:0	VAC1_ADC	0	N	N	R	VAC1 ADC reading, LSB: 1mV

Register Address: 0x39 Register Name: VAC2\_ADC

Bit	Bit Name	Default	WDT RST	REG RST	Type	Description
15:0	VAC2_ADC	0	N	N	R	VAC2 ADC reading, LSB: 1mV

Register Address: 0x3B Register Name: VBAT\_ADC

Bit	Bit Name	Default	WDT RST	REG RST	Type	Description
15:0	VBAT_ADC	0	N	N	R	VBAT ADC reading, LSB: 1mV

Register Address: 0x3D Register Name: VSYS\_ADC

Bit	Bit Name	Default	WDT RST	REG RST	Type	Description
15:0	VSYS_ADC	0	N	N	R	VSYS ADC reading, LSB: 1mV

Register Address: 0x3F Register Name: TS\_ADC

Bit	Bit Name	Default	WDT RST	REG RST	Type	Description
15:0	TS_ADC	0	N	N	R	TS ADC reading. LSB: 0.098%

Register Address: 0x41 Register Name: TDIE\_ADC

Bit	Bit Name	Default	WDT RST	REG RST	Type	Description
15:0	TDIE_ADC	0	N	N	R	TDIE ADC reading, LSB: 1°C Reported in 2's complement for negative value.

Register Address: 0x43 Register Name: DP\_ADC

Bit	Bit Name	Default	WDT RST	REG RST	Type	Description
15:0	DP_ADC	0	N	N	R	D+ ADC reading, LSB: 1mV

Register Address: 0x45 Register Name: DM\_ADC

Bit	Bit Name	Default	WDT RST	REG RST	Type	Description
15:0	DM_ADC	0	N	N	R	D- ADC reading, LSB: 1mV

Register Address: 0x47 Register Name: DPDM\_MANU\_CTRL

Bit	Bit Name	Default	WDT RST	REG RST	Type	Description
7:5	DP_CTRL	000	N	N	R/W	D+ manual control 000: HIZ (Default) 001: 0 010: 0.6V 011: 1.2V 100: 2.0V 101: 2.7V 110: 3.3V 111: Reserved
4:2	DM_CTRL	000	N	N	R/W	D- manual control 000: HIZ (Default) 001: 0 010: 0.6V 011: 1.2V 100: 2.0V 101: 2.7V 110: 3.3V 111: Reserved
1:0	RESERVED	00	N	N	R	Reserved

Register Address: 0x48 Register Name: DEVICE\_INFO

Bit	Bit Name	Default	WDT RST	REG RST	Type	Description
7	RESERVED	0	N	N	R	Reserved
6:3	DEVICE_ID	1100	N	N	R	1100: RT9490
2:0	RESERVED	000	N	N	R	Reserved

Register Address: 0x49 Register Name: PUMP\_EXP

Bit	Bit Name	Default	WDT RST	REG RST	Type	Description
7	PE_EN	0	Y	Y	RWSC	0: Disable (Default) 1: MTK Pump Express process enable (Back to 0 while PE done or no VBUS)
6	PE_SEL	0	Y	Y	R/W	0: PE 1.0 process select (Default) 1: PE 2.0 process select
5	PE10_INC	0	Y	Y	R/W	0: PE 1.0 voltage down (Default) 1: PE 1.0 voltage up
4:0	PE20_CODE	00000	Y	Y	R/W	MTK PE 2.0 Voltage Request Setting 00000: 5.5V (Default) 00001: 6V ... 11101: 20V 11110: Adapter healthy self-testing 11111: Disable cable drop compensation

Register Address: 0x4A Register Name: ADD\_CTRL 0

Bit	Bit Name	Default	WDT RST	REG RST	Type	Description
7	DIS_I2C_TO	0	Y	Y	R/W	Reset I <sup>2</sup> C slave after RT9490 latch SDA low for 1s 0: Enable I <sup>2</sup> C time-out function (Default) 1: Disable I <sup>2</sup> C time-out function
6	QON_RST_EN	1	Y	Y	R/W	0: QON pin = 0 for 10s will NOT do any thing 1: QON pin = 0 for 10s will turn off Ship FET and stop switching to reset system power (Default)
5	AUTO_AICR	1	Y	Y	R/W	0: No action 1: Auto set IAICR by BC1.2 done (Default)
4	TD_EOC	1	Y	Y	R/W	End-of-charge deglitch time 0: 2ms 1: 64ms (Default)
3	EOC_RST	0	Y	Y	RWC	0: No action (Default) 1: Reset EOC Auto clear after reset EOC done
2	AUTO_MIVR	1	Y	Y	R/W	0: No action 1: Auto set MIVR by VBUS plug-in (Default)
1	JEITA_COOL_VSET	1	Y	Y	R/W	0: Set VBAT_REG = JEITA_VSET_WARM setting (REG0x17[7:5]) 1: VBAT_REG = Register setting (Default)
0	JEITA_COLD_HOT	0	Y	Y	R/W	0: JEITA_COLD or JEITA_HOT, stop charge/OTG (Default) 1: JEITA_COLD or JEITA_HOT, still charge/OTG

Register Address: 0x4B Register Name: ADD\_CTRL 1

Bit	Bit Name	Default	WDT RST	REG RST	Type	Description
7:5	RESERVED	000	N	N	R	Reserved
4	PWM_1MHZ_EN	0	N	Y	R/W	Enable PWM frequency 1MHz mode 0: PWM frequency follow PWM_FREQ (Default) 1: Enable PWM frequency at 1MHz
3	OTG_PIN_EN	0	Y	Y	R/W	0: OTG pin function disable (Default) 1: OTG pin function enable
2	OTG_EN_CONTROL	0	Y	Y	R/W	OTG mode enable with OTG pin 0: Enable OTG mode by OTG_EN bit (Default) 1: Enable OTG by both OTG_EN bit and OTG pin
1:0	SEAMLESS_CONTROL	00	Y	Y	R/W	00: Disable (Default) 01: Seamless on VBUS 10: Seamless on VAC1 11: Seamless on VAC2

Register Address: 0x4C Register Name: ADD\_CTRL 2

Bit	Bit Name	Default	WDT RST	REG RST	Type	Description
7	BC12_EN_CHANNEL	0	Y	Y	R/W	BC12 detect channel 0: VAC1 (Default) 1: VAC2
6:5	DCDT_SEL	10	Y	Y	R/W	BC1.2 Data contact timer 00: Disable DCD timeout function 01: Enable 300ms DCD timeout function 10: Enable 600ms DCD timeout function (Default) 11: Wait data contact
4	VLGC_OPT	0	Y	Y	R/W	Enable primary detection high reference voltage option 0: Disable (Default) 1: Enable
3	DPDM_CMP_HYS_EN	1	Y	Y	R/W	DPDM detection hysteresis enable control 0: Disable 1: Enable (Default)
2	SPEC_TA_EN	1	Y	Y	R/W	0: Disable Special TA detection 1: Enable Special TA detection (Default)
1:0	HOST_MODE	00	Y	Y	R/W	Host mode setting in OTG 00: DPDM floating (Default) 01: SDP 10: CDP 11: DCP

Register Address: 0x4D Register Name: ADD\_IRQ\_FLAG

Bit	Bit Name	Default	WDT RST	REG RST	Type	Description
7	IEOC_FLAG	0	N	N	R	IEOC flag 0: Not trigger IEOC (Default) 1: Trigger IEOC STAT, read clear
6	VSYS_SHORT_FLAG	0	N	N	R	Short circuit protect between VSYS-VBAT flag 0: Not trigger VSYS_SHORT (Default) 1: Trigger VSYS_SHORT, read clear
5	REGN_PROTECT_FLAG	0	N	N	R	REGN overcurrent or undervoltage protection flag 0: Not trigger REGN_PROTECT (Default) 1: Trigger REGN_PROTECT, read clear
4	PE_DONE_FLAG	0	N	N	R	Pump Express process flag 0: PE_DONE_FLAG not rising (Default) 1: While PE processing done, read clear
3	VBUS_UNDER_MIVR_FLAG	0	N	N	R	VBUS falling under MIVR flag 0: VBUS not falling under MIVR (Default) 1: VBUS falling under MIVR, read clear
2	VRECHG_FLAG	0	N	N	R	Recharger event flag 0: No event happen (Default) 1: VBAT < VRECHG after EOC, read clear
1	CDP_PD_FLAG	0	N	N	R	CDP primary detection start 0: CDP primary detection does not start (Default) 1: CDP primary detection starts, read clear
0	CDP_DONE_FLAG	0	N	N	R	CDP flow done 0: No CDP flow (Default) 1: CDP flow done, read clear

Register Address: 0x4E Register Name: ADD\_IRQ\_MASK 6

Bit	Bit Name	Default	WDT RST	REG RST	Type	Description
7	IEOC_MASK	1	N	N	R/W	0: Not mask IRQ of IEOC_FLAG 1: Mask IRQ of IEOC_FLAG (Default)
6	VSYS_SHORT_MASK	1	N	N	R/W	0: Not mask IRQ of VSYS_SHORT_FLAG 1: Mask IRQ of VSYS_SHORT_FLAG (Default)
5	REGN_PROTECT_MASK	1	N	N	R/W	0: Not mask IRQ of REGN_PROTECT_FLAG 1: Mask IRQ of REGN_PROTECT_FLAG (Default)
4	PE_DONE_MASK	1	N	N	R/W	0: Not mask IRQ of PE_DONE_FLAG 1: Mask IRQ of PE_DONE_FLAG (Default)
3	VBUS_UNDER_MIVR_MASK	1	N	N	R/W	0: Not mask IRQ of VBUS_UNDER_MIVR_FLAG 1: Mask IRQ of VBUS_UNDER_MIVR_FLAG (Default)
2	VRECHG_MASK	1	N	N	R/W	0: Not mask IRQ of VRECHG_FLAG 1: Mask IRQ of VRECHG_FLAG (Default)
1	CDP_PD_MASK	1	N	N	R/W	0: Not mask IRQ of CDP_PD_FLAG 1: Mask IRQ of CDP_PD_FLAG (Default)
0	CDP_DONE_MASK	1	N	N	R/W	0: Not mask IRQ of CDP_DONE_FLAG 1: Mask IRQ of CDP_DONE_FLAG (Default)

## Application Information

*Richtek's component specification does not include the following information in the Application Information section. Thereby no warranty is given regarding its validity and accuracy. Customers should take responsibility to verify their own designs and reserve suitable design margin to ensure the functional suitability of their components and systems.*

### Power-On-Reset (POR)

The device powers internal bias circuits from the higher voltage of VAC1 / VAC2, VBUS, VBATP and VBAT. When VAC1/ VAC2 rises above VAC\_UVLO, VBUS rises above VBUS\_UVLO, VBATP rises above VBATP\_UVLO or VBAT rises above VBAT\_UVLO, I<sup>2</sup>C interface is ready for communication and all the registers are reset to default value.

- **PROG Pin for Cell and Frequency Setting**

During POR stage, the device detects the PROG pin pull-down resistance, and then sets register 0x0A[7:6]

for BATTERY\_CELL and register 0x13[5] for PWM\_FREQ. Please follow Table 1 for PROG pin pull-down resistor selection. The pull-down resistor on PROG pin is recommended to have ±1% to 2% tolerance for its resistance.

- **BATTERY\_CELL for Default Charging Parameter**

After PROG pin detected, the BATTERY\_CELL will set by PROG pull-down resistance, and then the following registers in Table 2 will be set by BATTERY\_CELL for default charging parameters.

**Table 1. PROG Pin Resistance for Cell and Frequency Setting**

Cell	Resistance for Typical Value	Frequency	BATTERY_CELL	PWM_FREQ
2s	6.04kΩ	1.5MHz	01	0
	8.2kΩ	750kHz		1
3s	10.5kΩ	1.5MHz	10	0
	13.7kΩ	750kHz		1
4s	17.4kΩ	1.5MHz	11	0
	27.0kΩ	750kHz		1

**Table 2. Default Register Setting for Charging Parameter by BATTERY\_CELL**

BATTERY_CELL (REG0x0A[7:6])	2s	3s	4s
VSYSMIN (REG 0x00[5:0])	7V	9V	12V
VBAT_REG (REG 0x01[10:0])	8.4V	12.6V	16.8V
VBAT_REG range	5V to 9.99V	10V to 13.99V	14V to 18.8V
ICHG_CTRL (REG 0x03[8:0])	2A	1A	1A

After POR, the charging parameters shown in Table 2 can be programmed by I<sup>2</sup>C; however, the VBAT\_REG has programming range regarding BATTERY\_CELL setting, so the host needs to ensure the program value within the right range. If the host programs the value out of the range, the charger will ignore and keeps at the original value. The charging parameters in Table 2 can be changed by programming BATTERY\_CELL. When

the host needs to program any parameter in REG0x0A, the host must program REG0x0A at first, then the host can program other registers.

• **Device Power Up from Battery Only**

When only Battery is present and VBATP above VBATP\_UVLO, the SHIPFET turns on to connect VBATP to VBAT. Then, when VBAT above VBAT\_UVLO, the BATFET turns on to connect VBAT to VSYS. The REGN stays off to minimize the quiescent current. The low quiescent current on VBAT and low RDS(ON) of BATFET minimizes device power consumption and conduction loss, which maximize battery run life.

The device always monitors the discharge current through BATFET (Battery Supply Mode). When the system is shorted or overloaded (IBAT > IBAT\_OCP), if

SHIP\_FET\_PRESENT = 1 (0x14, bit[7]) and EN\_BATOC = 1 (0x14, bit[0]), the device turns off SHIPFET and BATFET immediately to enter Shipping Mode until VBUS is plugged in again or uses the methods to Exit Shipping Mode to re-enable BATFET.

**Dual-Input Power Selection**

The charger has two ACDRV drivers to control optional back-to-back N-channel MOSFET for input power source selection. During POR, ACDRV pin detects whether optional AC-RBFET is present or not, then updates status to ACRB1\_STAT and ACRB2\_STAT. Table 3 shows the detailed status.

**Table 3. Optional AC-RBFET Status for Input Power Selection**

Scenario	AC-RBFET 1 present	AC-RBFET 2 present	ACDRV1 pin	ACDRV2 pin	ACRB1_STAT	ACRB2_STAT
Single Input	N	N	GND	GND	0	0
One AC-RBFET	Y	N	Gate	GND	1	0
	N	Y	GND	Gate	0	1
Dual Input	Y	Y	Gate	Gate	1	1

• **Single Input**

In this scenario, input power source comes only from VBUS, both of VAC1 and VAC2 connect to VBUS. After POR, control register EN\_ACDRV1 and EN\_ACDRV2 keep at 0.

• **One AC-RBFET**

In this scenario, only AC-RBFET1 or AC-RBFET2 is present; for example, only AC-RBFET1 is present, the ACDRV1 connects to AC-RBFET1 gate, and the ACDRV2 pulls down to GND. VAC2 connects to VBUS. After POR, register EN\_ACDRV2 keeps at 0.

1. When  $VAC1 > VAC_{UVLO}$ , the charger forces register EN\_ACDRV1 = 1 to turn on AC-RBFET1.
2. To swap input source from VAC1 to another power source, at first, the host has to set register DIS\_ACDRV\_EN = 1 to force EN\_ACDRV1 = 0 to turn off AC-RBFET1; after  $VBUS < VBUS_{UVLO}$ , the host enables another power source to directly connect to VBUS for input power source.

• **Dual Input**

In this scenario, both of AC-RBFET1 and AC-RBFET2 are present.

1. VAC1 is plugged in, when  $VAC1 > VAC_{UVLO}$ , the charger sets register EN\_ACDRV1 = 1 to turn on AC-RBFET1.
2. Then VAC2 is plugged in, when  $VAC2 > VAC_{UVLO}$ , the charger still sets register EN\_ACDRV1 = 1.
3. To swap input power source from VAC1 to VAC2, the host has to set EN\_ACDRV1 = 0 and EN\_ACDRV2 = 1 at the same time, after register is programmed, charger turns off AC-RBFET1.
4. After  $VBUS < VBUS_{UVLO}$ , the charger automatically turns on AC-RBFET2 to swap input power source from VAC1 to VAC2.
5. When VAC2 is plugged out, after  $VAC2 < VAC_{UVLO}$ , then charger sets EN\_ACDRV2 = 0 to turn off AC-RBFET2.



6. After  $V_{BUS} < V_{BUS\_UVLO}$ , charger automatically sets  $EN\_ACDRV1$  from 0 to 1 to turn on AC-RBFET1.
7. When  $V_{AC1}$  is plugged out, after  $V_{AC1} < V_{AC\_UVLO}$ , the charger sets  $EN\_ACDRV1 = 0$  to turn off AC-RBFET1.

If both  $V_{AC1} > V_{AC\_UVLO}$  and  $V_{AC2} > V_{AC\_UVLO}$ , and the host sets  $EN\_ACDRV1 = 1$  and  $EN\_ACDRV2 = 1$ , the charger will ignore and keep original register setting. The charger does not allow to turn on AC-RBFET1 and AC-RBFET2 at the same time.

**Device Power Up from Input Power Source**

When input power is present on  $V_{BUS}$ , after  $V_{BUS}$  is above  $V_{BUS\_UVLO}$ , the power up sequence is as listed:

1. Power up REGN LDO.
2. Poor Source Detection
3.  $V_{BUS\_STAT}$  detection is based on input source type to set default AICR register.
4. The device detects voltage on  $ILIM\_HZ$  pin to set  $ILIM$ , the final input current limit is based on the minimum value between AICR and  $ILIM$ .
5. The device detects voltage on  $V_{BUS}$  to set default MIVR register.
6. Buck-boost converter power-up.

**Power-Up REGN LDO**

The REGN LDO supplies for internal bias circuit and the buck-boost power MOSFET gate driver. The REGN also provides bias to  $TS$  and  $ILIM\_HZ$  external resistor and pull-up rail of  $STAT$  and  $PG$ . The REGN is enabled when the below conditions are valid:

1.  $V_{BUS}$  is above  $V_{BUS\_UVLO}$
2. The charger is in OTG mode.
3. ADC  $TS$  channel is on ( $ADC\_EN = 1$  and  $TS\_ADC\_DIS = 0$ )
4. DPDM manual mode is on ( $DP\_CTRL$  or  $DM\_CTRL$  is on)

The REGN is disabled when the below conditions are valid:

1. Only  $V_{BAT}$  with ADC  $TS$  channel is off, DPDM manual mode is off and not in OTG mode.

2. The device in HZ mode and BC1.2 is disabled.

**Poor Source Detection**

After REGN powers up, the device checks the current capability of the input source. The input source has to meet the following requirements to turn on the buck converter.

1.  $V_{BUS}$  below  $V_{BUS\_OVP\_RISE}$ .
2.  $V_{BUS}$  above  $V_{BUS\_BAD\_ADP}$  then pulling  $IBUS\_BAD\_ADP$  (typical =  $1k\Omega$ ).

When input source passes above conditions, the  $V_{BUS\_GD\_RDY\_STAT}$  and the  $V_{BUS\_GD\_RDY\_FLAG}$  turn to high and  $INT$  pin is pulsed for interrupting the host. If  $V_{BUS\_GD\_RDY\_STAT}$  does not turn to high, it repeats poor source detection every 2 seconds. After 8 times failures, the device sets register  $EN\_HZ = 1$  and goes to HZ mode. The register  $EN\_HZ$  can be cleared to 0 by adapter re-plug in or the host sets the  $EN\_HZ = 0$ . When  $V_{BUS}$  triggers poor source detection failure, the  $BAD\_ADAPTER\_FLAG$  turns to high and  $INT$  pin is pulsed for interrupting the host.

**$V_{BUS}$  Source Type Detection**

After  $V_{BUS\_GD\_RDY\_STAT}$  turns to high, the device runs  $V_{BUS}$  source type detection. After detection is completed, the  $BC12\_DONE\_STAT$  and  $BC12\_DONE\_FLAG$  turn to high and  $INT$  pin is pulsed for interrupting the host. When  $V_{BUS}$  source type detection is completed, the following registers are changed:

1.  $V_{BUS\_STAT}$  is updated to indicate  $V_{BUS}$  source type.
2. AICR register is changed to the result of  $V_{BUS\_STAT}$  automatically if  $AUTO\_AICR = 1$ , AICR setting result is listed in Table 4.

**Table 4. AICR Setting from D+/D- Detection**

Detection	AICR Setting	$V_{BUS\_STAT}$
USB SDP	0.5A	0001
USB CDP	1.5A	0010
USB DCP	3.25A	0011
NSDP	3.25A	0101
Special Adapter	1A/2A/2.1A/2.4A	0110

The device supports standard USB BC1.2 and special adapter, detection result is listed in Table 5.

**Table 5. AICR Setting from Special Adapter**

D+/D- Voltage Threshold	AICR Setting
0.9V < D+ < 1.5V	2A
1.5V < D+ < 2.3V 2.3V < D-	1A
D+ > 2.3V D- < 2.3V	2.1A
D+ > 2.3V D- > 2.3V	2.4A

### Average Input Current Regulation (AICR)

The range of AICR is from 100mA to 3.3A with 10mA resolution. When register AUTO\_AICR is set to 1, the device changes AICR automatically after VBUS source type detection, refer to Table 4 and Table 5 for detailed information. After charger automatically sets AICR, register AICR is programmable by the host.

### ILIM\_HZ Detection

After Poor source detection, the charger starts to ADC voltage on ILIM\_HZ pin, and calculate the ILIM by the equation:  $V_{ILIM\_HZ} = 1V + 800m\Omega \times ILIM$ . When register ILIM\_HZ\_EN is set to 1, the charger input current limit is set by the minimum value between AICR and ILIM. If the ILIM calculation result is less than 100mA, the charger clamps ILIM at 100mA.

When the ILIM\_HZ pin is pulled lower than 0.75V, the charger stops switching and REGN stays on either in charger or OTG mode. The charger resume switching when the ILIM\_HZ pin voltage rises higher than 1V.

### Minimum Input Voltage Regulation (MIVR)

The MIVR function prevents input voltage from dropping due to insufficient current provided from input power source. The VBUS voltage decreases to VMIVR setting level when the overcurrent condition of input power source occurs. The register VMIVR default setting is 3.6V; It can be programmed by the host, with the range from 3.6V to 22V with 0.1V resolution. If the register AUTO\_MIVR is set to 1, after poor source detection, the charger starts to ADC voltage on VBUS before the charger starts switching, the register VMIVR will be set to VBUS-0.7V when VBUS\_ADC < 7V, or set to VBUS-

1.4V when VBUS\_ADC  $\geq$  7V.

During charge process, if the input voltage is changed, when the register FORCE\_MIVR\_DET is set to 1 by the host, the charger stops switching and ADC voltage on VBUS to re-update VBUS\_ADC; according to above calculation equation, the register VMIVR updates to the new value, and the charger resumes switching.

When DIS\_EOC\_FCCM = 0 to enable FCCM to increase EOC accuracy, the MIVR setting level must set -25% voltage difference from VBAT\_REG to avoid converter from working in Buck-Boost operation mode when VBUS plug out.

### Converter Power-Up

After the Input and MIVR is set, the converter is enabled and starts switching. BATFET stays on unless charger is disabled (CHG\_EN = 0 or EN\_PIN is pulled high).

The device integrates a synchronous PWM controller with high-accuracy current and voltage regulation, and the switching frequency is programmed with 750kHz/1.5MHz by the register PWM\_FREQ or PROG pin. The device supports PFM control to improve light-load efficiency, also supports OOA (Out-of-Audio) control by the register DIS\_CHG\_OOA to prevent converter from switching in audio frequency.

### OTG Mode Operation

The RT9490 also supports OTG (On-The-Go) mode and enters OTG mode via register EN\_OTG. The maximum output current is up to 3.32A. In OTG mode, the VBUS\_STAT register bits is updated to 0111, the VBUS output voltage is 5V and output limit current is 3A by default, output voltage (VOTG), output current limit (IOTG) and input current limit (IBAT\_REG) can be programmed by the host. The OTG mode operation can be enabled by following condition:

- VBAT is above VOTG\_LBP rising threshold.
- EN\_OTG is set to high.
- Voltage at TS pin is within acceptable range ( $V_{VTS\_HOT\_OTG} < V_{TS} < V_{VTS\_COLD\_OTG}$ ).

When above conditions are passed, refer to Table 3 for AC\_RBFET configuration for below setting.

• **Single Input**

In this scenario, there is no any AC-RBFETs, the converter starts up with 4ms delay after register EN\_OTG is set to 1, then VBUS voltage rises to the VOTG setting.

• **One AC-RBFET**

In this scenario, only AC-RBFET1 or AC-RBFET2 is present; for example, if only AC-RBFET1 is present, when register EN\_OTG is set to 1.

1. The converter starts up with 4ms delay after register EN\_ACDRV1 is set to 1, then VAC1 voltage rises to the VOTG setting.
2. If register DIS\_ACDRV\_EN is set to 1, the converter starts up with 4ms delay, then VBUS voltage rises to the VOTG setting.

• **Dual Input**

In this scenario, both of AC-RBFET1 and AC-RBFET2 are present, when register EN\_OTG is set to 1.

1. The converter starts up with 4ms delay after register EN\_ACDRV1 is set to 1, then VAC1 voltage rises to the VOTG setting.
2. To swap OTG output from VAC1 to VAC2, register EN\_ACDRV1 is set to 0 and EN\_ACDRV2 is set to 1, the device pulls low ACDRV1 pin to turn off AC-RBFET1, and pulls up ACDRV2 pin to turn on AC-RBFET2, and then VAC2 voltage rises to VOTG setting.
3. If register DIS\_ACDRV\_EN is set to 1, the device forces EN\_ACDRV1 and EN\_ACDRV2 at 0, the converter starts up with 4ms delay, then VBUS voltage rises to VOTG setting.

In OTG mode, if the host sets EN\_ACDRV1 = 1 and EN\_ACDRV2 = 1, the device will ignore and keep original register setting. The charger does not allow to turn on AC-RBFET1 and AC-RBFET2 at the same time.

In OTG mode, the device supports PFM control to improve light-load efficiency, also supports OOA (Out-of-Audio) control by the register DIS\_OTG\_OOA to prevent converter from switching in the audio frequency.

In OTG mode, the device monitors discharge current

from battery. When battery discharge current is higher than register IBAT\_REG setting, the device start to decrease OTG output current to keeps the systems power at the first, if the system power still increases, when OTG output voltage falls below OTG\_UVP, the converter will turn off to maintain system power.

**IBAT Regulation During OTG Mode**

The range of IBAT\_REG is from 3A to 5A with 1A resolution. In OTG mode, when the discharge current from battery is over IBAT\_REG setting, the converter starts to decrease output voltage to regulate output power from battery. The device also supports IBAT\_REG disable after converter starts switching in OTG mode. When IBAT\_REG is set at 11 to disable IBAT\_REG before converter starts switching in OTG mode, the IBAT\_REG will be set to default setting.

**Power Path Management**

The device provides automatic power path selection to supply system (VSYS) from VBUS, VBAT (battery) or both of them.

• **SHIPFET Control**

The device supports SDRV driver for optional SHIPFET. With optional SHIPFET, after POR, the register SHIP\_FET\_PRESENT must set to 1 by the host, and the SHIPFET is controlled by the register SDRV\_CTRL.

• **IDLE**

When BATH is higher than VBAT\_UVLO rising threshold, the SDRV pin turns on SHIPFET and the device powers on for default register setting.

• **Shutdown Mode**

To extend battery life when shipping or storage, the device supports extremely minimum battery leakage current with shutdown mode. When device enters Shutdown Mode, the device turns off SHIPFET, internal BATFET and circuit. The only way for device to exit shutdown mode to restore power for system is by plug-in VBUS, and all registers return to default setting when the device exits shutdown mode. When in battery only condition, the device can enter shutdown mode.

• **Ship Mode**

When device enters ship mode, the device turns off SHIPFET and internal BATFET. The device can exit Ship Mode to restore power for system by the following method:

1. VBUS plug in
2. Set SDRV\_CTRL to IDLE
3. Set RST\_ALL or REG\_RST bit to reset all registers to default
4. Press QON pin from high to low.

When in battery only condition, the device can enter Ship Mode.

• **System Power Reset**

The device supports system reset via SDRV\_CTRL by the host. When entering System Power Reset, the device turns off SHIPFET and BATFET; after 600ms, the device restores power for system and SDRV\_CTRL goes back to IDLE. The device can enter System Power Reset even with VBUS plug in.

The host can set SDRV\_DLY = 0 to turn off SHIPFET and BATFET immediately or set SDRV\_DLY = 1 to delay 10s to turn off SHIPFET and BATFET.

• **QON Pin Operation**

The QON pin has two functions to control SHIPFET and BATFET. The register SHIP\_FET\_PRESENT must set to 1 by the host to enable QON function.

▶ **Exit Ship Mode**

Press QON pin from high to low with deglitch time by the register QON\_EXIT\_SHIP\_DLY setting time, the device turns on SHIPFET and BATFET to restore power for system

▶ **SYSTEM Reset**

With register QON\_RST\_EN is set to 1, press QON pin from high to low with deglitch time 10s, the

device turns off SHIPFET and BATFET, after 600ms, the device turns on SHIPFET and BATFET to restore power for system.

**Battery Charging Management**

The device has charge current up to 5A with 9mΩ BATFET to improve charge efficiency and decrease voltage drop during battery discharging.

• **Charging Cycle**

When battery charging is enabled (CE pin set to low and EN\_CHG = 1), the device autonomously completes a charging cycle without host controls. The device default parameters are shown in Table 2. The host can also change charging parameters through I<sup>2</sup>C.

A charging cycle starts with the following condition:

1. Buck-Boost converter starts.
2. Battery charging is enabled (CE pin is low, EN\_CHG = 1)
3. Without any thermal fault on TS
4. No safety timer fault

The charger is in “end of charge status” when the charging current is below EOC current threshold, battery voltage is above recharge voltage threshold, and device not in AICR, MIVR, JEITA, CYC\_OCP or thermal regulation.

When battery voltage is discharged below recharge threshold (threshold setting through VRECHG register bits), the device restarts a new charging cycle automatically. After the charge is done, toggle CE pin or CHG\_EN can restart a new charging cycle.

• **Battery Charging Profile**

The device charges the battery in five statuses: trickle charge, pre-charge, constant current, constant voltage and back-ground charge (optional).

**Table 6. Charging Current Setting**

Current Parameter	Default Current Setting	CHG_STAT
I <sub>TRICKLE_CHG</sub>	100mA	001
I <sub>PRE_CHG</sub>	120mA	010
I <sub>CHG_REG</sub>	2A (2s)/1A (3s, 4s)	011 (CC Mode)/100 (CV Mode)
I <sub>EOC_CHG</sub>	200mA	111

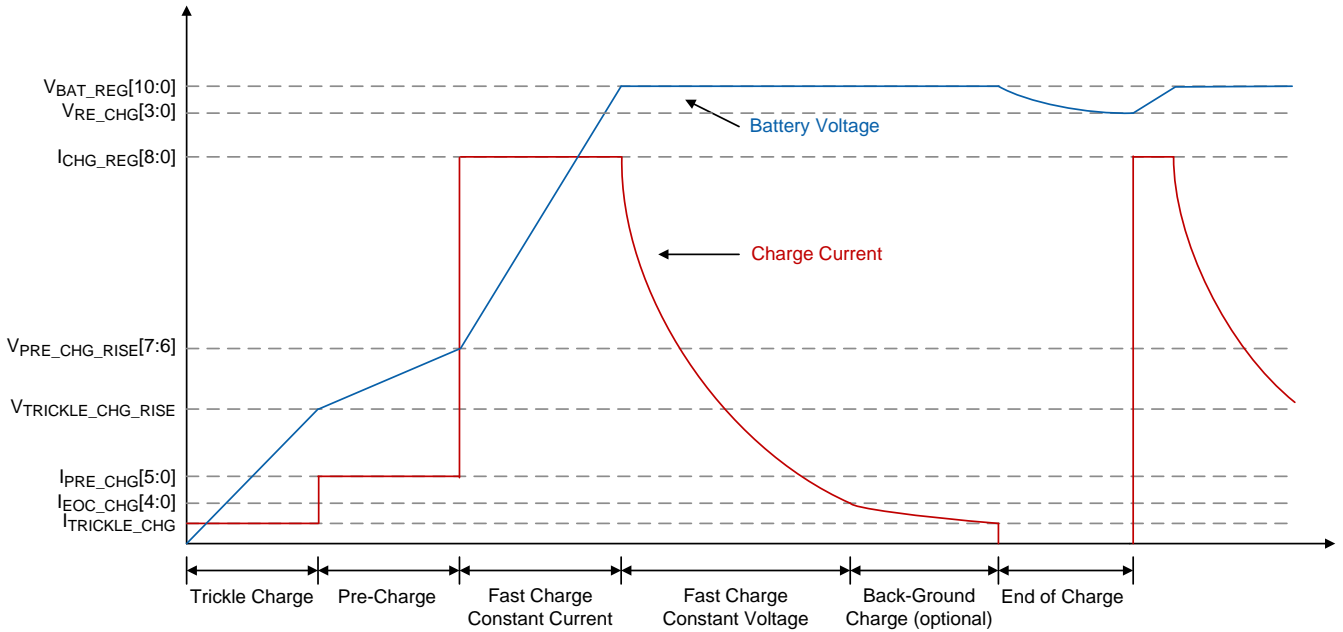

Figure 1. Charging Profile

• End of Charge (EOC)

The charger enters end of charge status when battery voltage is above recharge threshold, and the charge current is below IEOC\_CHG. IEOC\_CHG setting range is from 120mA to 1000mA with 40mA resolution. After EOC, the BATFET turns off with register EN\_TE = 1 and BG\_CHG\_TMR = 00, and the buck boost

converter keeps switching to supply power to the system. BATFET will turn on again when battery voltage is under recharge voltage threshold or device is in Battery Supply Mode during EOC.

When EOC occurs, there are four conditions as shown in Table 7:

Table 7. EOC Status Scenario

	TE = 1 BG_CHG_TMR (disable)	TE = 1 BG_CHG_TMR (counting)	TE = 1 BG_CHG_TMR (timeout)	TE = 0 BG_CHG_TMR (disable)
STAT Pin	High	High	High	Low
CHG_STAT	111	110	111	101
BATFET	OFF	ON	OFF	ON

1. If the device triggers AICR, MIVR, JEITA, CYC\_OCP or thermal regulation status during charging, the actual charging current will be less than the programmed value. In this condition, EOC function will be disabled, and the safety timer's counter clock rate will be half.
2. The back-ground charge can be applied after EOC is detected. The back-ground charge is enabled by setting register BG\_CHG\_TMR and EN\_TE = 1 only. When back-ground charge

occurs, the CHG\_STAT is set to 110, and the BATFET will turn off after back-ground charge timer expires.

3. The BG\_CHG\_TMR gets reset at one of the following conditions:
  - ▶ EN\_CHG disable to enable
  - ▶ EOC status re-trigger
  - ▶ EOC\_RST bit is set
  - ▶ REG\_RST bit is set

- ▶ RST\_ALL bit is set

An INT pulse is asserted to host when entering back-ground charge and back-ground charge timer expires.

- When DIS\_EOC\_FCCM = 1, the IEOC accuracy will lower than Electrical Characteristic table. The device use DIS\_EOC\_FCCM = 0 to increase accuracy, please refer to MIVR function for application notice.

● **Optimized VDS on BATFET**

The device deploys power path function with BATFET separating system from battery. The minimum system voltage is set by register VSYSMIN. The default VSYSMIN setting is controlled by PROG pin.

When the battery voltage is under VSYSMIN setting, the BATFET operates in saturation mode as LDO and the system voltage is typically 200mV above the VSYSMIN setting. When the battery voltage rises above VSYSMIN, BATFET turns fully on to minimize RDS(ON) for optimizing VDS (voltage different between VSYS and VBAT) on BATFET.

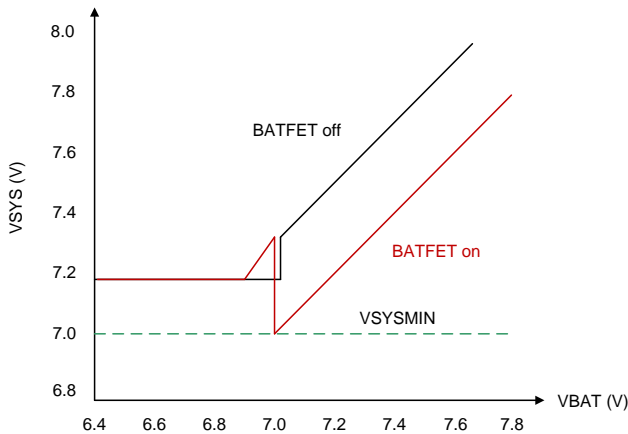

Figure 2. VSYS vs. VBAT for 2s Battery

When BATFET turns off and battery voltage is above VSYSMIN, the system is regulated at typically 300mV above battery voltage. The status register VSYSMIN\_STAT = 1 when the system is in minimum system voltage regulation.

● **DIS\_LDO Mode**

When the battery voltage is under VSYSMIN setting, the BATFET operates in saturation mode as LDO, and the maximum charge current will be limited under 2A. The device supports disabling LDO mode via register DIS\_LDO set to 1 by the host. When DIS\_LDO = 1, the BATFET turns fully on even when battery voltage is under VSYSMIN setting, and the VSYS will not regulate on VSYSMIN setting. In DIS\_LDO mode, the charge current follows the ICHG\_CTRL/IPRE\_CHG setting. The DIS\_LDO mode only operates when battery voltage is above VTIRCKLE\_CHG\_RISE.

**Power Management System**

To apply maximum current and avoid over loading from the power source on VBUS, the device’s Power Management System continuously monitors the power source voltage and current. When power source is overloaded, either the current exceeds the AICR or the voltage drops to MIVR, the device will reduce the charge current to priority power energy for system.

When the charge current is reduced to zero, but power source still triggers AICR or MIVR, the VSYS starts to drop. Once the VSYS drops under VBAT, the device automatically change to battery supply mode, and the BATFET turns fully on and battery starts to discharge so that the system is supported from both battery and power source.

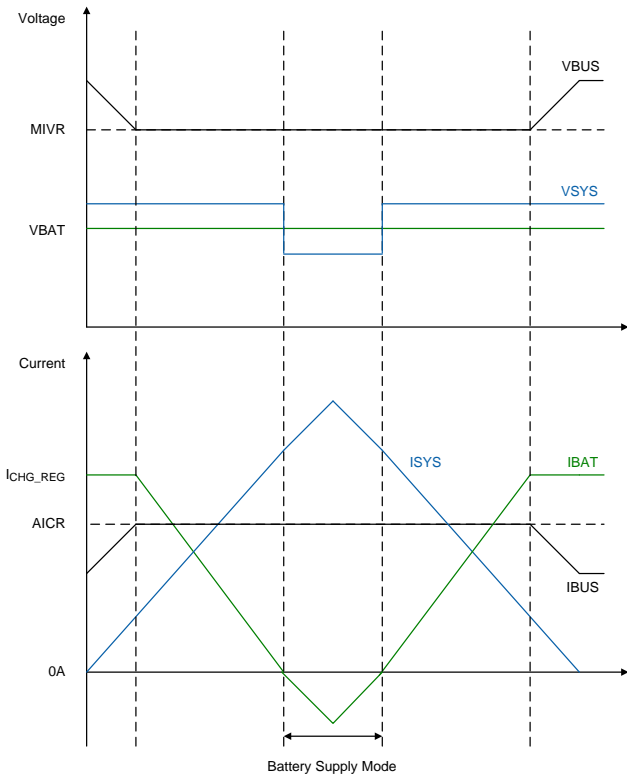

Figure 3. Power Management System

• **Battery Supply Mode**

During charge status, when voltage difference between VBAT and VSYS is above 50mV, the BATFET turns on and the BATFET gate regulates the gate driver of BATFET to minimize VBAT-VSYS voltage to stay at 25mV to prevent entering and exiting the battery supply mode frequently. When the voltage of VBAT-VSYS is below 0mV, the charger exits the battery supply mode, and starts to charge battery.

• **JEITA Protection During Charge Mode**

The device provides a single thermistor input for temperature monitor.

To achieve battery thermal protection, JEITA guidelines were released in 2007.

To start a charge cycle, the voltage on TS pin must be in the T1 to T4 range. The device will stop charging if the battery temperature is lower than T1 (Cold) or higher than T4 (Hot).

In this case, the JEITA\_COLD\_STAT = 1 or JEITA\_HOT\_STAT = 1 and an INT is asserted to the host.

In cool temperature range (T1 to T2), the charge current is reduced to 50% or 25% of ICHG\_REG (configured by JEITA\_ISET\_COOL).

In warm temperature range (T3 to T4), the voltage setting of VBAT\_REG is reduced or the same as VBAT\_REG (configured by JEITA\_VSET\_WARM).

The device provides more flexible settings than JEITA requirement.

In cool temperature range (T1 to T2), the charger can set voltage of VBAT\_REG (configured by JEITA\_VSET\_COOL).

In warm temperature range (T3 to T4), the charge current can be reduced to 50% or 25% of ICHG\_REG (configured by JEITA\_ISET\_WARM).

The device supports temperature threshold setting for COOL (T2) and WARM (T3) by register TS\_COOL and TS\_WARM.

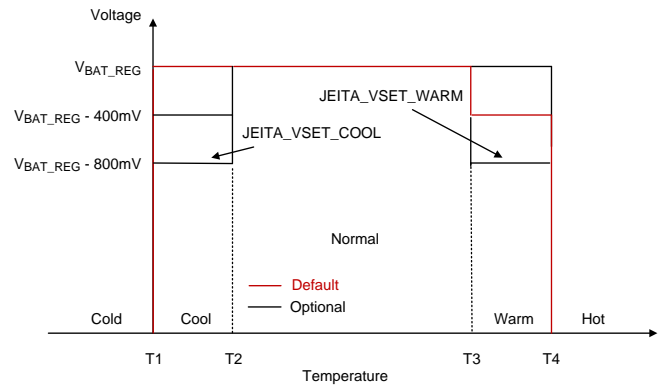
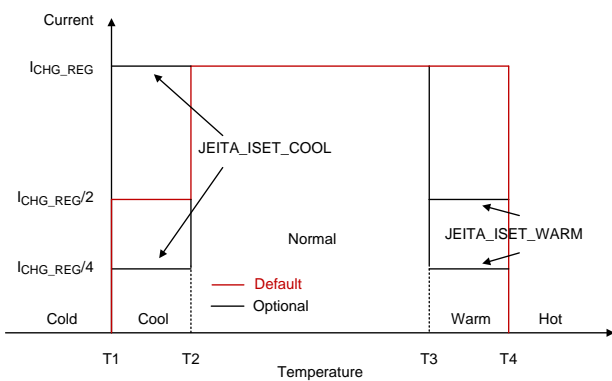

Figure 4. JEITA Protection for Charging Current and Voltage

There are four sections implemented for JEITA protection. Based on RHOT and RCOLD, RTS1 and RTS2 can be calculated with equation (1) and (2). Herein, RHOT is the NTC resistance of battery over-temperature threshold, and RCOLD is the NTC resistance of battery under-temperature threshold.

$$R_{TS1} = V_{REGN} \times [(1/V_{T1} - 1/V_{T4}) / (1/R_{COLD} - 1/R_{HOT})] \dots\dots\dots(1)$$

$$R_{TS2} = R_{TS1} \times [1/(V_{REGN} / V_{T1} - R_{TS1} / R_{COLD} - 1)] \dots\dots\dots(2)$$

**Thermal Protection During OTG Mode**

To start a OTG mode to discharge from battery, the voltage on TS pin must be in T0 to T4 range. The device will stop converter if the battery temperature is lower than T0 (OTG\_COLD) or higher than T4 (OTG\_HOT). In this case, the JEITA\_COLD\_STAT = 1 or JEITA\_HOT\_STAT = 1 and an INT is asserted to the host.

Once temperature returns to normal range, the OTG mode is recovered.

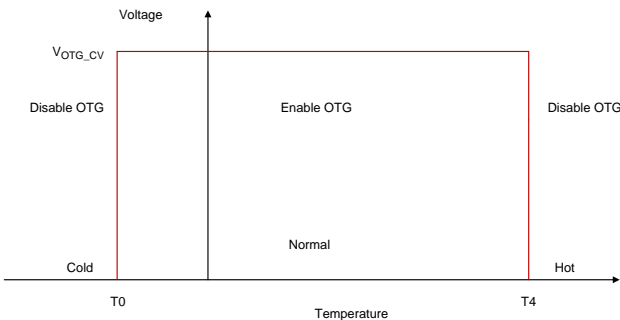

Figure 5. Thermal Protect during OTG Mode

The device supports temperature threshold setting for COLD (T0) and HOT (T4) by register OTG\_COLD and OTG\_HOT.

**Charging Safety Timer**

The device has safety timer to prevent abnormal charging time due to poor battery condition. The device can be set EN\_TRICHG\_TMR, EN\_PRECHG\_TMR and EN\_FASTCHG\_TMR for each charging stage. When the safety timer expires, the device stops charging, the TRICHG\_TMR\_STAT, PRECHG\_TMR\_STAT, or FASTCHG\_TMR\_STAT = 1, and an INT is asserted to the host. The safety timer can be disabled by the host.

Table 8. Charging Safety Timer

VBAT	Safety Timer
< VTRICKLE_CHG	1 hour
< VPRE_CHG	0.5 hours, 2 hours (Default)
> VPRE_CHG	5 hours, 8 hours, 12 hours (Default), 24 hours

When the charger in AICR, MIVR, JEITA cool, JEITA warm, thermal regulation or CYC\_OCP, the safety timer's counter clock rate will be half.

For example, if charger in AICR status, and timer setting is 12 hours, the actual safety timer will expire in 24 hours. The extended charge timer setting can be disabled by setting TMR2X\_EN = 0.

The safety timer will be reset by:

1. Toggle  $\overline{CE}$  pin
2. CHG\_EN disable/enable
3. Safety timer disable/enable
4. REG\_RST or RST\_ALL is set.
5. System Power Reset

**Adaptive Input Current Control**

The AICC function provides an adaptive AICR setting to prevent input voltage drops. When the input power source is overcurrent and the VBUS drops to the MIVR level, set EN\_AICC bit to 1, the device will automatically decrease AICR level step by step until exit MIVR event. Once AICC is finished, EN\_AICC bit keeps at 1 and the adaptive AICR setting is updated to register IAICC, AICC\_STAT = 10 and an INT is asserted to the host to indicate AICC\_FLAG.

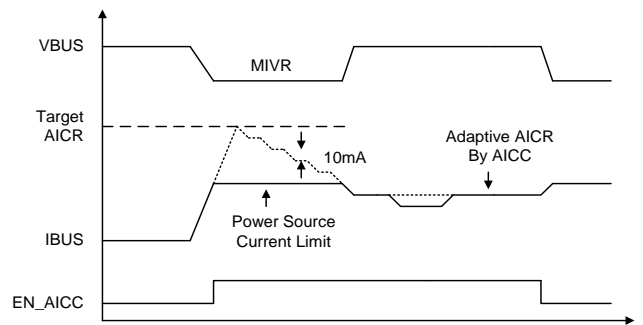

Figure 6. AICC Enable



The device supports re-enable AICC function by setting FORCE\_AICC = 1, after AICC done, the FORCE\_AICC goes back to 0. FORCE\_AICC can be set to 1 after EN\_AICC enable. The AICC function only is enabled when EN\_AICC = 1.

**MediaTek Pump Express+ (MTK, PE+)**

The device can provide an input current pulse to communicate with an MTK-PE+ high voltage adapter. When PE\_EN bit is enabled, the device can increase or decrease adapter output voltage by setting PE10\_INC or PE20\_CODE to the desired value. After enabling PE function, the device will generate a VBUS current pattern for the MTK-PE+ adapter to automatically identify whether to increase or decrease output voltage. Once the PE pattern is finished, PE\_EN bit will clear to 0, and an INT is asserted to the host to indicate PE\_DONE\_FLAG.

**Watchdog Timer (WDT)**

When the device is controlled by host, most of the registers can be programmed by host. The host has to write WD\_RST = 1 to reset counter before watchdog timeout and it can disable WDT function by setting WATCHDOG bits to 00, SDRV\_CTRL bits to 01 or 10. When the watchdog timer expires, WDT\_STAT and WDT\_FLAG turn to high, INT pin is pulsed for interrupting the host, and the related registers are reset to default values. (Refer to Register Description for details). If the device is in watchdog timeout status, host can write any registers or WD\_RST = 1 to return counting.

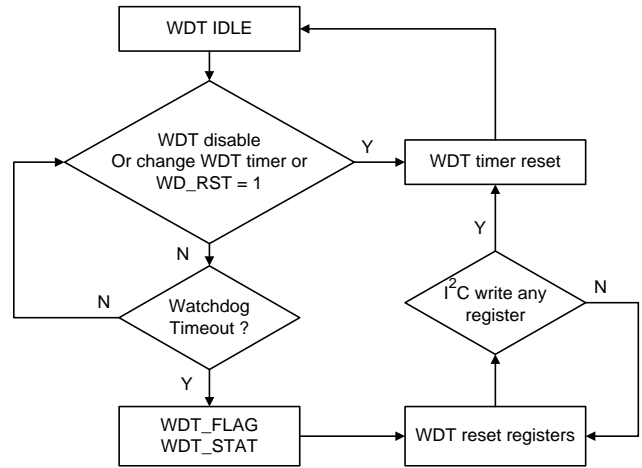

Figure 7. WDT Flow Chart

**Status Outputs and OTG Pin Control**

• **Power Good Indicator (PG Pin)**

The PG pin goes low to indicate a good power source when:

1. VBUS above VBUS\_UVLO, and RBADSR is applied.
2. VBUS below VBUS\_OVP threshold setting
3. HZ = 0 (not in HZ mode)
4. The charger thermal is under THREG threshold setting
5. Completed VBUS Source Type Detection

• **Charging Status Indicator (STAT/OTG Pin)**

The device supports multi-function on STAT/OTG pin. When register DIS\_STAT = 0, the STAT/OTG pin configure as a STAT pin.

The device indicates CHG\_STAT and any charge fault on STAT pin. The STAT pin is an open drain that can be used to drive LED. The STAT pin function can be disable by setting the DIS\_STAT = 1.

Table 9. STAT Pin State

CHG_STAT	STAT Indicator
Trickle, Pre, Fast charge, IEOC (EOC and TE = 0)	Low
Charge done, Back-Ground charge	High
Not charging (Without any charge fault)	High
Not charging (VBAT_OVP/VSYS_OVP/VBUS_OVP/OTP/Safety timer timeout)	Blinking at 1Hz

### • Interrupt to Host ( $\overline{\text{INT}}$ pin)

The device reports IRQ to host by the  $\overline{\text{INT}}$  pin, which is an open drain output.

The  $\overline{\text{INT}}$  pin generates a pulse low with 256 $\mu$ s when IRQ event occurs.

When an IRQ occurs, the device pulses an  $\overline{\text{INT}}$  to the host and keeps IRQ event in register 0x28 to 0x2D and 0x4D until the host reads the IRQ registers. Before the host reads IRQ registers to clean IRQ events, the device will not send any INT pulse again unless any new event occurs.

The IRQ events in register 0x28 to 0x2D are unmasked by default, and in register 0x4D is masked by default.

### Fast Role Swap (FRS)

The device supports multi-function on STAT/OTG pin. When register DIS\_STAT = 1 and OTG\_PIN\_EN = 1, the STAT/OTG pin is configured as an OTG pin.

The device supports Fast Role Swap (FRS) by the following registers setting and steps:

1. Set DIS\_STAT = 1 and OTG\_PIN\_EN = 1
2. The device starts charging, the CHG\_STAT is not in the Not charging status.
3. Set EN\_OTG = 1 and OTG\_EN\_CONTROL = 1

When adapter plugs out, after VBUS drops lower than VMIVR setting, and OTG pin is pulled up to high, the device translates from charge mode to OTG mode. Refer to OTG Mode Operation for detailed OTG setting.

### Seamless

The device supports Seamless to automatically translate device from charge mode to OTG mode to keep VBUS voltage output after adapter plugs out.

The device starts Seamless by the following registers setting and steps:

1. The device starts charging, the CHG\_STAT is not in the Not charging status
2. Set SEAMLESS\_CONTROL not at 00

When adapter plugs out, after VBUS drops lower than VMIVR setting, the device automatically translates from charge mode to OTG mode to keep VBUS voltage on

VOTG setting. The register EN\_OTG auto set to 1 and SEAMLESS\_CONTROL set to 00 by device. Refer to OTG Mode Operation for detailed OTG setting.

### ADC Conversion Operation

The device supports 16-bit resolution and 11 channels ADC for device information monitoring. The ADC operation is set when ADC\_EN = 1, and set ADC\_CONV\_CTRL for One shot mode or Continuous mode.

After power-on reset (POR), when ADC\_EN = 1, the ADC results are updated to the register for each channel after ADC conversion. In One-shot mode, an INT pulse is asserted to the host to indicate ADC\_DONE.

The IBAT\_ADC and IBUS\_ADC support charging current sensing in charge mode, and discharging current sensing in OTG mode, which report with 2's complement for ADC result. With only battery, the device only provides IBAT\_ADC for discharging current sensing, in this case, the register IBAT\_PIN\_EN also must be set to 1, and the IBAT\_ADC will report 2's complement result for ADC result.

When TS\_ADC, DP\_ADC and DM\_ADC is enabled, the register EN\_HZ must be set to 0. During ADC conversion, the REGN turns on even if the device is only with battery, and RENG keeps on when ADC operates in Continuous mode.

### IBAT Pin for Battery Current Sensing

The device supports an analog output on IBAT pin for charging or discharging current sensing. When IBAT\_PIN\_EN is set to 1, the IBAT pin output is 250mV when 1A current sensing via 10k $\Omega$  resistor connected to GND. During charge mode, the IBAT pin outputs charging current sensing result; when the system load rise and the device enter battery supply mode, the IBAT pin will output 0V as no charging current result.

### DP/DM Output Control Manual Mode

The device supports DP/DM output control manual mode by programmed DP\_CTRL/DM\_CTRL. When DP\_CTRL/DM\_CTRL is not set at 000, the EN\_HZ also must be set to 0, after REGN turns on, the manual control output voltage will be provided on DP/DM.

When the adapter is plugged in, the device will ignore manual control setting during BC1.2 detection. When BC1.2 is done, an INT is asserted to the host to indicate BC1.2\_DONE and DPDM\_DONE, and then the manual control will be enabled.

## DP/DM HOST Mode

The device supports HOST mode to configure the DP/DM as a SDP/CDP/DCP port compatible to standard BC1.2 by programmed HOST\_MODE.

## Protections

### • VBUS Overvoltage Protection in Charge Mode

If VBUS voltage is over VBUS\_OVP rising threshold, the device stops switching immediately and an INT pulse is asserted to the host. When VBUS overvoltage, the status VBUS\_OVP\_STAT = 1 and the CHG\_STAT = 000 for stop charging. The device resumes to normal operation when VBUS voltage drops below the VBUS\_OVP falling threshold.

### • VBUS Overvoltage Protection in OTG Mode

If VBUS voltage is over VOTG\_OVP rising threshold, the device stops switching immediately and an INT pulse is asserted to the host. When VBUS is overvoltage, the status OTG\_OVP\_STAT = 1. The device resumes to normal operation when VBUS voltage drops below the VOTG\_OVP falling threshold.

### • VAC Overvoltage Protection

If VAC voltage is over VAC\_OVP setting (programmable by VAC\_OVP bits), the device sets EN\_ACDRV = 0 to turn off external ACRBFET, and an INT pulse is asserted to the host. For example, if VAC1 voltage over VAC\_OVP setting, the EN\_ACDRV1 is set to 0, the status VAC1\_OVP\_STAT = 1. The device resumes to normal operation when VAC1 voltage drops below the VAC\_OVP falling threshold.

### • IBUS Overcurrent Protection in Charge Mode

The device monitors currents between VBUS and PMID to provide overload protection. If the IBUS current is over IBUS\_OCP threshold, the device will set EN\_HZ = 1 to stop switching immediately, also set DIS\_ACDRV\_EN = 1 to turn off external ACRBFETs and an INT pulse is asserted to the host. The IBUS

overload protection can be disabled by setting EN\_IBUS\_OCP to 0.

### • OTG Undervoltage Protection

The device monitors OTG output voltage and current to provide VBUS short circuit protection. If VBUS voltage is under VOTG\_UVP threshold, the device stops switching. If short circuit is detected on VBUS, the OTG will hiccup 7 times. If converter retries are not successful, EN\_OTG bit will set to 0 to disable OTG mode an INT pulse is asserted to the host to indicate OTG\_UVP. The hiccup can be disabled by DIS\_VOTG\_UVP\_HICCUP to 1; when hiccup is disabled, the converter continues switching even if VBUS voltage is under VOTG\_UVP threshold.

### • VSYS Overvoltage Protection

If VSYS voltage is over VSYS\_OVP rising threshold, the device stops switching immediately and an INT pulse is asserted to the host. When VSYS is overvoltage, the status VSYS\_OVP\_STAT = 1. The device provides resistance sink source on VSYS to bring down the VSYS voltage. The device resumes to normal operation when VSYS voltage drops below the VSYS\_OVP falling threshold.

### • VSYS Undervoltage Protection

The device monitors VSYS output voltage to provide VSYS undervoltage protection. If VSYS voltage is under VSYS\_UVP threshold, the device stops switching and an INT pulse is asserted to the host. If short circuit is detected on VSYS, the converter will hiccup 7 times. If converter retries are not successful, EN\_HZ bit will be setting to 1 to enter HZ mode. Re-plug in adapter or set EN\_HZ to 0 can exit HZ mode and the converter restarts to switch. The hiccup can be disabled by DIS\_VSYS\_UVP\_HICCUP to 1; when hiccup is disabled, the converter continues switching even if VSYS voltage is under VSYS\_UVP threshold.

### • VSYS Short Protection

The device monitors VSYS output voltage to provide VSYS short circuit protection. The VSYS short protection can only enabled by the following setting:

1. The device must have SHIPFET
2. The register SHIP\_FET\_PRESENT must be set to 1

When short circuit is detected on VSYS, the device will set SDRV\_CTRL to 10 to immediately enter Ship Mode to turn off SHIPFET and an INT pulse is asserted to the host to indicate VSYS\_SHORT.

- **VBAT Overvoltage Protection**

If VBAT voltage is over VBAT\_OVP rising threshold, the device stops switching immediately and an INT pulse is asserted to the host. When VBAT is overvoltage, the status VBAT\_OVP\_STAT = 1. The device provides resistance sink source on VBAT to bring down the VBAT voltage. The device resumes to normal operation when VBAT voltage drops below the VBAT\_OVP falling threshold.

- **IBAT Overcurrent Protection**

The system overload protection can only be enabled by the following setting:

1. The device must have SHIPFET
2. The register SHIP\_FET\_PRESENT must be set to 1
3. The register EN\_BATOC must be set to 1

When the system is overloaded ( $IBAT > I_{OCP\_BATFET}$ ), the device will set SDRV\_CTRL to 10 to immediately enter Ship Mode to turn off SHIPFET and an INT pulse is asserted to the host to indicate IBAT\_OCP.

- **Thermal Protection in Charge Mode**

The device monitors the internal junction temperature to avoid overheat. When in charge mode, the thermal regulation threshold is set at 120°C (programmable by register THREG bits). When junction temperature exceeds thermal regulation threshold, the device decreases the input current limit. During thermal regulation, EOC function is disabled, the safety

timer's counter clock rate will be half and an INT is asserted to the host indicate THREG.

The thermal regulation protection activates when EN\_AICR = 1.

In addition, the device has thermal shutdown protection, the thermal shutdown threshold is set at 150°C (programmable by register TOTP bits). When the IC junction temperature exceeds thermal shutdown threshold, the converter turns off immediately and an INT is asserted to the host indicate TOTP fault. The converter is recovered when the junction temperature is below  $T_{OTP} - T_{OTP\_HYS}$ .

- **Thermal Protection in OTG Mode**

The device monitors the internal junction temperature to avoid overheat. When in OTG mode, the thermal regulation threshold is set at 120°C (programmable by register THREG bits). When junction temperature exceeds thermal regulation threshold, the device decreases the output current limit, and an INT is asserted to the host to indicate THREG.

The thermal regulation protection activates when IBAT\_REG does not set at disable.

In addition, the device also has thermal shutdown protection in OTG mode.

- **Poor Source Detect Protection**

The device supports source sink on VBUS to detect whether the adapter is poor source or not. When poor source is detected, the device will hiccup 8 times. If device retries are not successful, the device will set EN\_HZ = 1 and an INT is asserted to the host to indicate BAD\_ADAPTER.

**Table 10. Protection Summary**

Channel	Threshold (Typ.)	Deglintch (Typ.)	Protection	Reset and Threshold (Typ.)
VBUS_OVP	VBUS_OVP rising	NA	Converter stop switching	VBUS_OVP falling
VAC_OVP	VAC_OVP rising	NA	Disable ACDRV1 or ACDRV2 to turn off external MOSFET	VAC_OVP falling
IBUS_OCP	IBUS_OCP rising	2ms	REG0x0F[2] = 1 to enter HZ to stop converter switching, and disable ACDRV1 or ACDRV2 to turn off external MOSFET.	NA
OTG_OVP	VOTG_OVP rising	NA	Converter stop switching	VOTG_OVP falling
OTG_UVP	VOTG_UVP falling	10ms	Converter start hiccup, after hiccup 7 times, REG0x12[6] = 0 to disable OTG. Hiccup can be programmed in REG0x13[2].	VOTG_UVP rising
SYS_OVP	VSYS_OVP rising	128μs	Converter stop switching	VSYS_OVP falling
SYS_UVP	VSYS_SHORT falling	64μs	Converter start hiccup, after hiccup 7 times, REG0x0F[2] = 1 to enter HZ to stop converter switching. Hiccup can be programmed in REG0x13[3].	VSYS_SHORT rising
SYS_SHORT	VBAT - VSYS rising to 200mV	128μs	With external SHIPFET, when trigger SYS_SHORT, the SDRV_CTRL enter Ship mode. The SYS_SHORT protect must set REG0x14[7] to 1.	NA
VBAT_OVP	VBAT_OVP rising	2ms	Converter stop switching	VBAT_OVP falling
IBAT_OCP	IOCP_BATFET rising	3ms	With external SHIPFET, when trigger IBAT_OCP, the SDRV_CTRL enter Ship mode. The IBAT_OCP protect must have to set REG0x14[7] to 1.	NA
Thermal Regulation	TJ_THREG rising	32ms	Limit converter output power	TJ_THREG falling
Poor Source Detect	VBUS_MIN falling	30ms	When poor source is detected, after 8 times hiccup, REG0x0F[2] = 1 to enter HZ.	VBUS_MIN rising

**Communication Interface**

The device uses I<sup>2</sup>C compatible interface by 2-wire line (SCL and SDA) to communicate with the host. The SCL and SDA pins are open drain, which needs to connect to supply voltage by pull-up resistors. The device operates as an I<sup>2</sup>C slave device with 7-bits address 53H, supports up to 3.4MHz conditionally. To start an I<sup>2</sup>C communication, beginning with START (S) condition, and then the host sends slave address. This address is 7-bit long followed by an eighth bit which is a data

direction bit (R/W). The second bytes is register address. The third byte contains data to the selected register. End with STOP (P) condition.

• **I<sup>2</sup>C Time-Out Reset**

To avoid I<sup>2</sup>C hang-ups, a timer runs during I<sup>2</sup>C activity. If the SDA keeps low longer than 1 second, the device will reset I<sup>2</sup>C to release SDA to go back to High. The I<sup>2</sup>C hang-ups reset function can be disabled by register DIS\_I2C\_TO = 1.

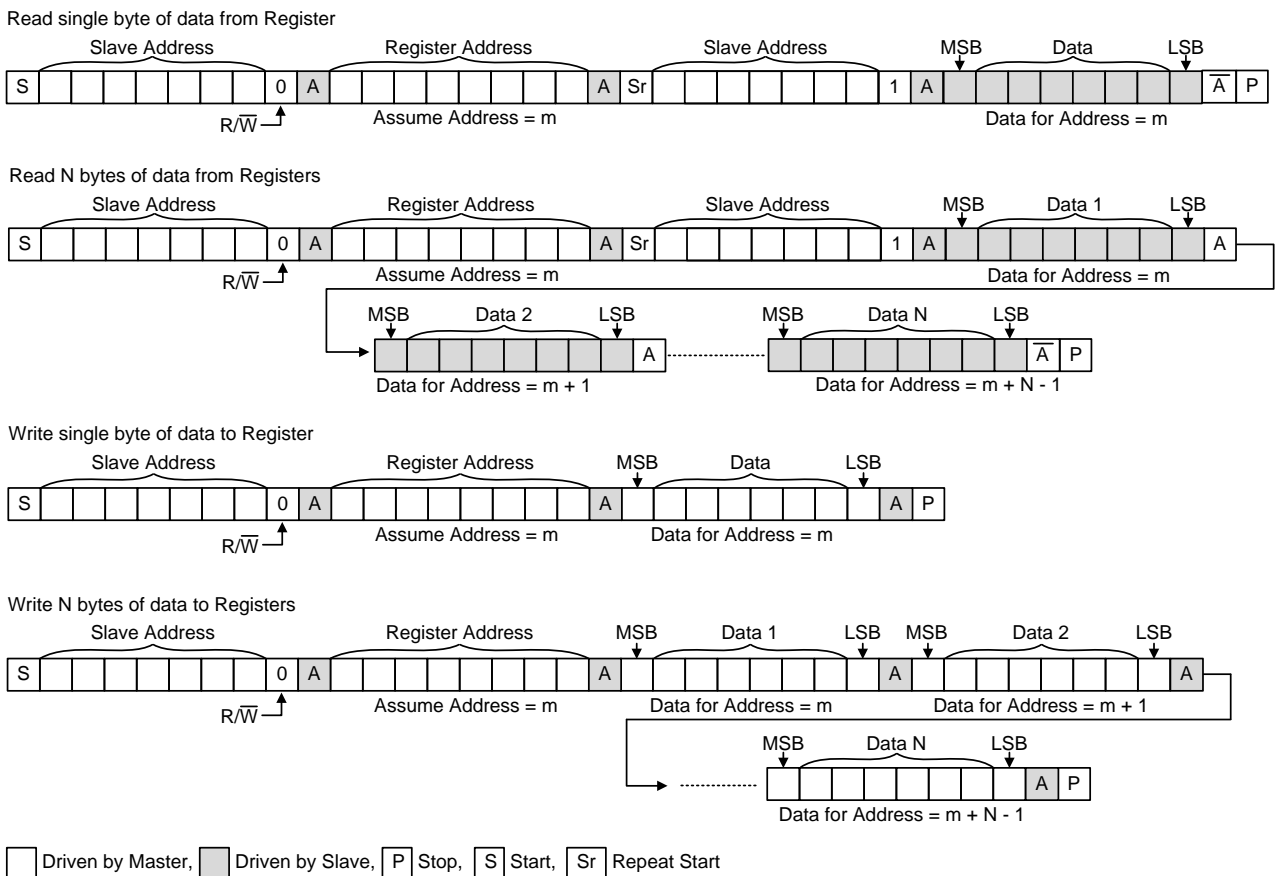

Figure 8. Read and Write Function

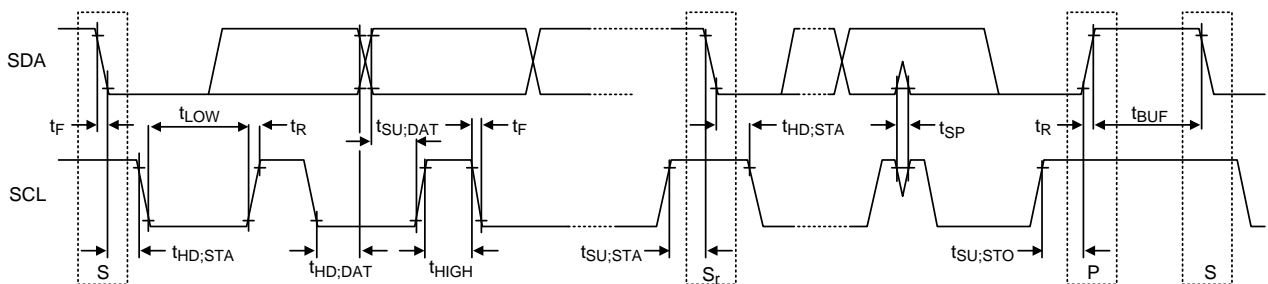

Figure 9. I<sup>2</sup>C Waveform Information

**Thermal Considerations**

The junction temperature should never exceed the absolute maximum junction temperature  $T_{J(MAX)}$ , listed under Absolute Maximum Ratings, to avoid permanent damage to the device. The maximum allowable power dissipation depends on the thermal resistance of the IC package, the PCB layout, the rate of surrounding airflow, and the difference between the junction and ambient temperatures. The maximum power dissipation can be calculated using the following formula:

$$P_{D(MAX)} = (T_{J(MAX)} - T_A) / \theta_{JA}$$

where  $T_{J(MAX)}$  is the maximum junction temperature,  $T_A$  is the ambient temperature, and  $\theta_{JA}$  is the junction-to-ambient thermal resistance.

For continuous operation, the maximum operating junction temperature indicated under Recommended Operating Conditions is 130°C. The junction-to-ambient thermal resistance,  $\theta_{JA}$ , is highly package dependent. For a WL-CSP-56B 2.93x3.46 (BSC) package, the thermal resistance,  $\theta_{JA}$ , is 31.7°C/W on a standard JEDEC 51-7 high effective-thermal-conductivity four-layer test board. The maximum power dissipation at  $T_A = 25^\circ\text{C}$  can be calculated as below:

$$P_{D(MAX)} = (130^\circ\text{C} - 25^\circ\text{C}) / (31.7^\circ\text{C/W}) = 3.31\text{W for a WL-CSP-56B 2.93x3.46 (BSC) package.}$$

The maximum power dissipation depends on the operating ambient temperature for the fixed  $T_{J(MAX)}$  and the thermal resistance,  $\theta_{JA}$ . The derating curves in Figure 10 allows the designer to see the effect of rising ambient temperature on the maximum power dissipation.

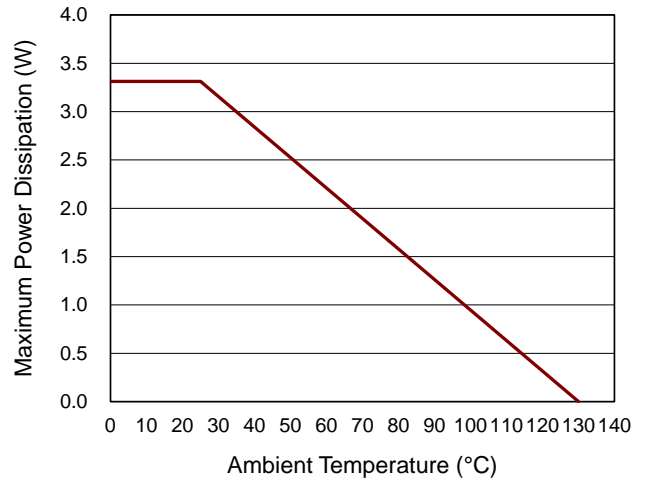

Figure 10. Derating Curve of Maximum Power Dissipation

## Layout Considerations

The RT9490 layout guidelines are shown as below, there are several suggestions provided.

- ▶ The capacitors connected to PMID pin needs to be placed as close as possible to the IC.
- ▶ The inductor connected to SW pin needs to not only router the trace as short as possible to reduce the EMI but also make sure copper area of the trace is wide enough for the operating current.
- ▶ The capacitors connected to VSYS pin need to be placed as close as possible to the IC. Three 10 $\mu$ F capacitors on Top, and two capacitors on Bottom.
- ▶ The capacitors connected to VBAT pin need to be placed as close as possible to the IC.
- ▶ The 0.1 $\mu$ F Capacitor, connected to VAC1/VAC2, PMID and VSYS must have to be placed close to the IC.
- ▶ The GND needs to connect on TOP layer with PMID and SYS capacitors, use ground vias to connect to main ground as close as possible to the IC, and use ground vias directly on GND pin (A4 to E4).



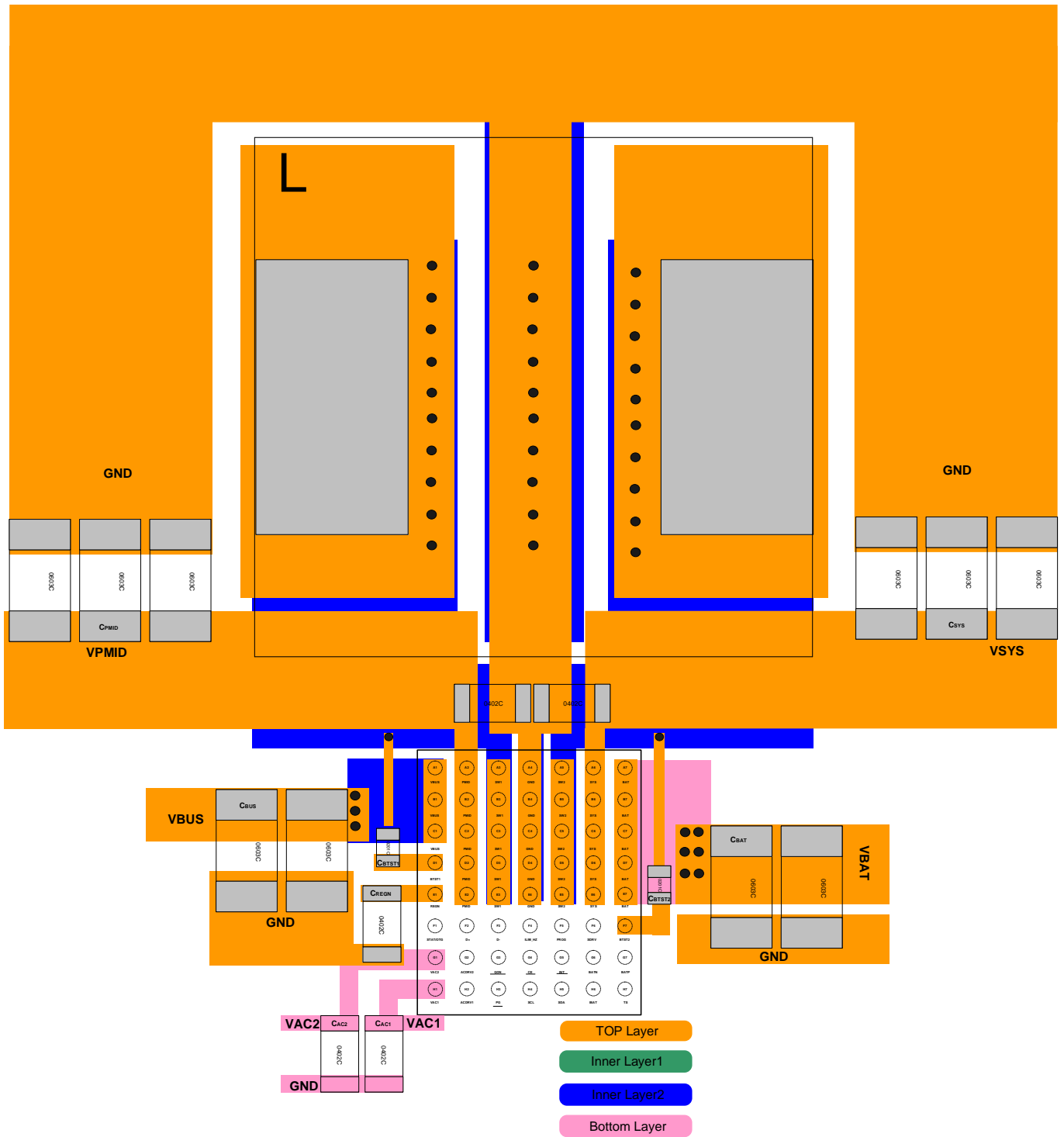
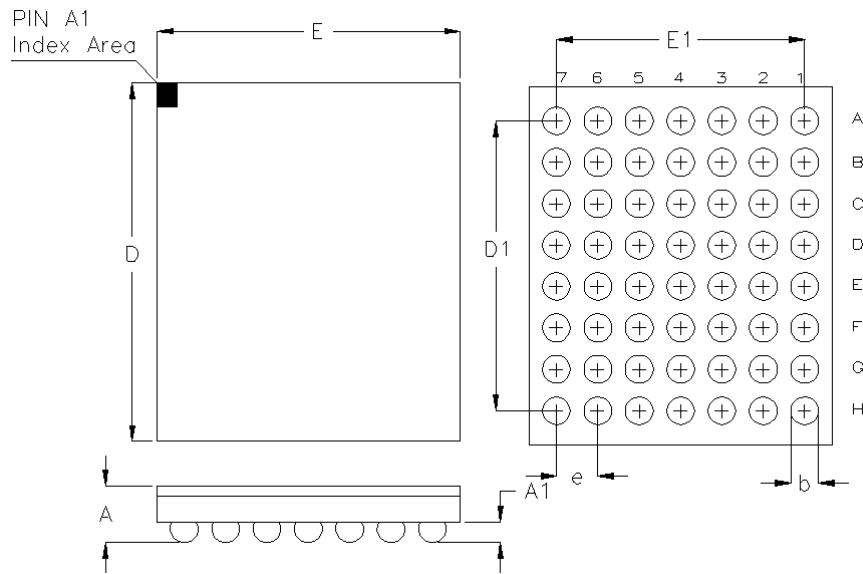

Figure 11. PCB Layout Guide

Outline Dimension



Symbol	Dimensions In Millimeters		Dimensions In Inches	
	Min	Max	Min	Max
A	0.500	0.600	0.020	0.024
A1	0.170	0.230	0.007	0.009
b	0.240	0.300	0.009	0.012
D	3.420	3.500	0.135	0.138
D1	2.800		0.110	
E	2.890	2.970	0.114	0.117
E1	2.400		0.094	
e	0.400		0.016	

56B WL-CSP 2.93x3.46 Package (BSC)

**Footprint Information**

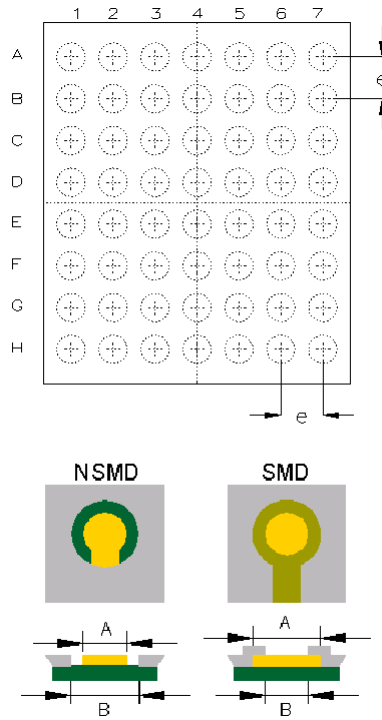

Package	Number of Pin	Type	Footprint Dimension (mm)			Tolerance
			e	A	B	
WL-CSP2.93x3.46-56(BSC)	56	NSMD	0.400	0.240	0.340	±0.025
		SMD		0.270	0.240	

## Packing Information

### Tape and Reel Data

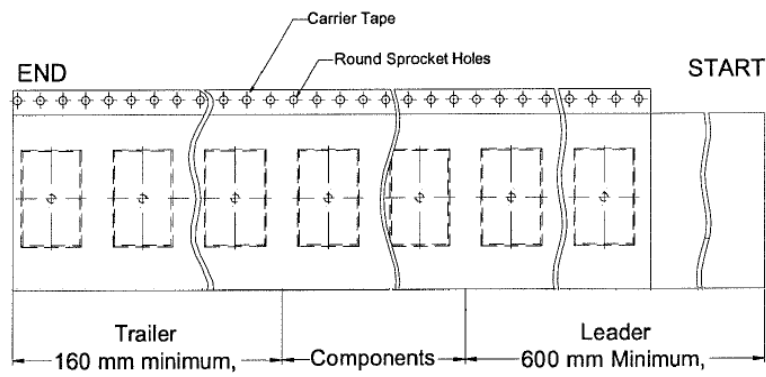
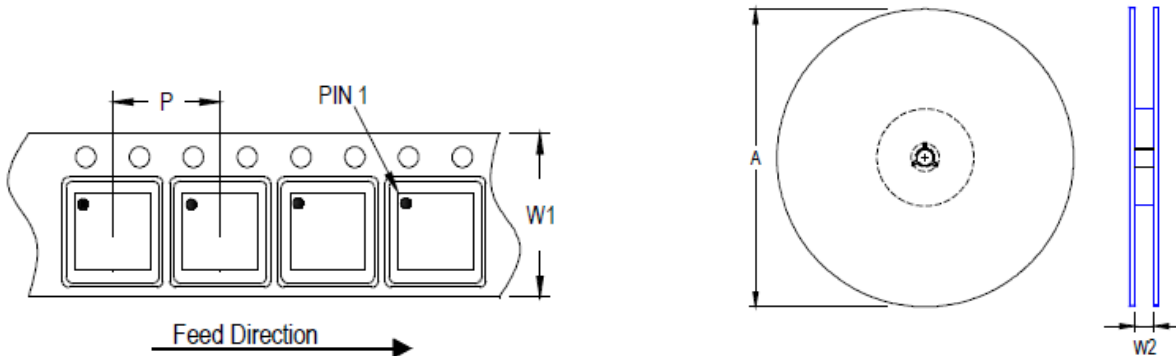



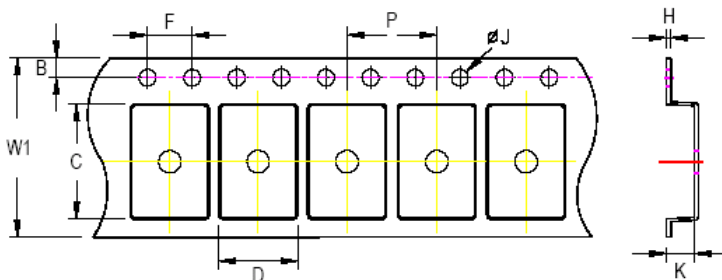

Package Type	Tape Size (W1) (mm)	Pocket Pitch (P) (mm)	Reel Size (A)		Units per Reel	Trailer (mm)	Leader (mm)	Reel Width (W2) Min./Max. (mm)
			(mm)	(in)				
WL-CSP 2.93x3.46	12	8	180	7	1,500	160	600	12.4/14.4



**C, D, and K are determined by component size.**  
**The clearance between the components and the cavity is as follows:**  
**- For 12mm carrier tape: 0.5mm max.**

Tape Size	W1		P		B		F		ØJ		H
	Max.	Min.	Max.	Min.	Max.	Min.	Max.	Min.	Max.	Max.	
12mm	12.3mm	7.9mm	8.1mm	1.65mm	1.85mm	3.9mm	4.1mm	1.5mm	1.6mm	0.6mm	

## Tape and Reel Packing

Step	Photo/Description	Step	Photo/Description
1	 <p>Reel 7"</p>	4	 <p>12 inner boxes per outer box</p>
2	 <p>Packing by Anti-Static Bag</p>	5	 <p>Outer box <b>Carton A</b></p>
3	 <p>3 reels per inner box <b>Box A</b></p>	6	

Package	Container		Reel					Box					Carton			
	Size	Units	Item	Size(cm)	Weight(Kg)	Reels	Units	Item	Size(cm)	Weight(Kg)	Boxes	Unit				
WL-CSP 2.93x3.46	7"	1,500	Box A	18.3*18.3*8.0	0.1	3	4,500	Carton A	38.3*27.2*38.3	0.8	12	54,000				
			Box E	18.6*18.6*3.5	0.03	1	1,500	For Combined or Partial Reel.								

## Packing Material Anti-ESD Property

Surface Resistance	Aluminum Bag	Reel	Cover tape	Carrier tape	Tube	Protection Band
$\Omega/\text{cm}^2$	$10^4$ to $10^{11}$	$10^4$ to $10^{11}$	$10^4$ to $10^{11}$	$10^4$ to $10^{11}$	$10^4$ to $10^{11}$	$10^4$ to $10^{11}$

## Richtek Technology Corporation

14F, No. 8, Tai Yuen 1<sup>st</sup> Street, Chupei City

Hsinchu, Taiwan, R.O.C.

Tel: (8863)5526789

Richtek products are sold by description only. Richtek reserves the right to change the circuitry and/or specifications without notice at any time. Customers should obtain the latest relevant information and data sheets before placing orders and should verify that such information is current and complete. Richtek cannot assume responsibility for use of any circuitry other than circuitry entirely embodied in a Richtek product. Information furnished by Richtek is believed to be accurate and reliable. However, no responsibility is assumed by Richtek or its subsidiaries for its use; nor for any infringements of patents or other rights of third parties which may result from its use. No license is granted by implication or otherwise under any patent or patent rights of Richtek or its subsidiaries.

**Datasheet Revision History**

Version	Date	Description	Item
01	2024/1/17	Modify	Title on P1 General Description on P1 Ordering Information on P1 Functional Block Diagram on P5 Electrical Characteristics on P8 to 19 Typical Operating Characteristics on P25, 26, 27, 29 Register Description on P30, 31, 33, Application Information on P63, 68, 69, 70, 72, 76, 79, 81